

Vickers®

Cylinders



Series TV Cylinders

ISO 6020-2 and DIN 24554 Interchangeable
Nominal Pressure: 160 bar Hydraulic
Working Pressure: Up to 210 bar Hydraulic



VICKERS

Revised 3/96

4147

Features

Global Design:

Engineered for ISO 6020-2/DIN 24554 interchangeability with the durability required for heavy-duty applications.

Rod Cartridge Assembly:

Quick Change design requires no other cylinder disassembly for rod seal maintenance.

SureSeal™ Sealing System:

Carefully selected wiper and seal combinations are mated with a hard chrome plated piston rod to deliver exceptional all-around performance and durability.

Special Wearbands:

Metal-to-metal contact is eliminated, providing superior wearability, increased load carrying capability, and prolonged cylinder life.

Piston Sealing System:

This system offers not only a selection of highly efficient seal materials, but also an extra wide wearband that rides smoothly within the precision-honed cylinder body to provide extended piston seal life.

Square Head Tie-Rod Design:

Suitable for nominal pressure to 160 bar and working pressure up to 210 bar.

Full Range of Ports:

Including SAE, ISO 228-1 BSPP, and metric to ISO 6149 and DIN standard 3852 to provide the broadest piping flexibility.

Piston Rod:

Case hardened, hard chrome plated piston rod in a variety of diameters between 12 and 140 millimeters provides maximum durability and extends seal life. Several different rod end types are available.

ISO Standard Seal Grooves:

Rod and piston sealing systems both conform to ISO standard groove specifications.

Captive Screws:

Inadvertent removal of cushion screws and optional air bleed screws is prevented, while still allowing a full range of adjustment.

Bore Size Range:

Cylinder bores available between 25 and 200 millimeters.

Fully Adjustable

Cushioning System:

This design has been engineered to provide the ability to tune the cushion performance for an optimized deceleration profile. Our patented floating ring cushion seal or an alternate ball check design allows maximum acceleration. This excellent acceleration profile translates into faster cycle times and increased production.

Attention to Details:

One example is the careful design of the body-to-head joint. The design assures ease of assembly while maintaining tight tolerances for exceptional concentricity between cylinder parts.

Contents

How to Order	3
Model Codes for ISO Cylinders	4
Model Codes for DIN Cylinders	6
Mounting Style	7
Mounting Style & Installation Dimensions	11
TV01 Side Lug Mounts.....	11
TV04 Keyed Side Lug Mounts.....	12
TV07 Head Rectangular Mounts (DIN).....	13
TV09 Head Rectangular Mounts (ISO).....	14
TV10 Clevis Mount.....	15
TV11 Spherical Bearing Mount.....	16
TV14 Cap Rectangular Mount	17
TV15 Intermediate Trunnion Mount.....	18
TV16 Cap Trunnion Mount.....	19
TV17 Head Trunnion Mount.....	20
TV21 Cap Extended Tie Rod Mount	21
TV22 Head Extended Tie Rod Mount.....	22
TV23 Both Ends Extended Tie Rod Mount.....	23
TV25 Double Rod End, Side Lug Mount.....	24
TV47 Cap Fixed Eye Mount.....	25
Accessories.....	26
Common Options Section.....	32
Application / Engineering Data.....	37
Application Data.....	42
Cushion Data.....	43
Energy Absorbing Potential Charts.....	44
Weights.....	47

How To Order

Standard Cylinders

Vickers has created an easy system for ordering Series TV Cylinders. This system has been developed to improve our service to you. The model code consists of sixteen alpha-numeric digits which fully describe the most common standard options offered on Series TV cylinders.

To specify your Series TV cylinder, review the following pages for a full description of each option available and select the desired code.

This model code system will:

- **Simplify the re-order process.**
Each Vickers Series TV cylinder is assigned a sixteen digit model code. That code is unique to a particular cylinder description. That way, when you re-order your Series TV cylinder, you're assured of exactly the same top quality cylinder design.
- **Improve identification.**
Every Series TV cylinder has its sixteen digit model code clearly marked on the product, impression stamped in the metal head or cap. Each sixteen digit code completely describes a specific cylinder. This allows seals and replacement components to be easily identified in the field.
- **Facilitate communications.**
This fully descriptive model code system allows you to work directly with your local Vickers sales engineer to identify and service your Vickers cylinder.

NOTE

See pages 4 and 5 for a summary of ISO 6020-2 model code options. See page 6 for a summary of DIN 24554 model code options.

Custom Cylinders

New Cylinders

Although the model code has been arranged to cover the vast majority of available options, there will be occasions when you require an option which cannot be coded. When specifying such an option, enter an "X" for the appropriate item in the sixteen digit model code, then describe your requirements. For example, if you have an application which requires a custom thread on the end of the piston rod, enter an "X" for item 7. Then add a full description at the end of the model code, such as "With 80mm total rod projection and M22 x 1,5 thread 35mm long." The cylinder will then be given a unique five digit design number on receipt of order (as explained below).

If more than one of the available options represented in items 15 and 16 are required, add the appropriate codes as a suffix. The cylinder will then be given a unique five digit design number on receipt of your order (as explained below).

Replacement Cylinders

Every Vickers custom cylinder is assigned a unique design number. This number is contained in the last five digits of the sixteen digit model code, and item 12 is always an alpha character. In other words, the "Stroke" and "Extra Rod Projection" locations (items 12 through 16) become the "Design Number" items for custom cylinders. When ordering a replacement cylinder, simply give the sixteen digit model code or the five digit design number to your local Vickers Sales Representative.

Replacement Parts

Each design number is stored in a quick retrieval computerized storage system. This gives our field sales representatives rapid access to assist you in identifying and specifying genuine Vickers replacement parts.

Model Codes for ISO 6020-2 Series TV Cylinders*

(All dimensions are in millimeters)

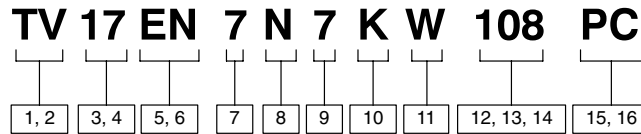

1, 2 Series
TV – ISO 6020-2 interchangeable hydraulic cylinder

5, 6 Bore and rod diameters

Code	Bore	Rod
BB –	25	12
BE –	25	18
2C –	32	14
2G –	32	22

7 Rod end type

Code	Type
0 –	Intermediate male metric thread
1 –	Short female metric thread
6 –	Plain no attachment
7 –	Small male metric thread
N –	Extended intermediate male metric thread

3, 4 Mounting style

Vickers Code	Style	ISO Code
01 –	Side lug	MS2
04 –	Keyed side lug	
09 –	Head rectangular	ME5
10 –	Cap clevis	MP1
11 –	Spherical bearing	MP5
14 –	Cap rectangular	ME6
15 –	Intermediate trunnion	MT4
16 –	Cap trunnion	MT2
17 –	Head trunnion	MT1
21 –	Cap extended tie rod	MX2
22 –	Head extended tie rod	MX3
23 –	Both ends extended tie rod	MX1
24 –	No mount	
25 –	Double rod, side lug	
33 –	Double rod, head rectangular	
34 –	Double rod, intermediate trunnion	
35 –	Double rod, head trunnion	
39 –	Double rod, extended tie rod	
40 –	Double rod, both ends extended tie rod	
41 –	Double rod, no mount	
47 –	Cap fixed eye	MP3

(See detailed information on page 8.)

CE –	40	18
CG –	40	22
CJ –	40	28
DG –	50	22
DJ –	50	28
DL –	50	36
EJ –	63	28
EL –	63	36
EN –	63	45
GL –	80	36
GN –	80	45
GQ –	80	56
HN –	100	45
HQ –	100	56
HS –	100	70
KQ –	125	56
KS –	125	70
KU –	125	90
LS –	160	70
LU –	160	90
LW –	160	110
NU –	200	90
NW –	200	110
NZ –	200	140

(See detailed information on page NO TAG.)

(See detailed information on page NO TAG.)

8 Sealing System

Code	Type
N –	Normal
L –	Low friction and water glycol
T –	High temperature

(See detailed information on page NO TAG.)

9 Port type and size

Code	Type
3 –	SAE/UN O-ring
4 –	Oversize SAE/UN
5 –	NFPA standard SAE/UN
6 –	SAE 4-bolt manifold
7 –	BSPP
8 –	Oversize BSPP
9 –	Metric
0 –	Oversize metric
A –	ISO 6149 O-ring
B –	Oversize ISO 6149 O-ring

(See detailed information on page NO TAG.)

* See page 6 for DIN 24554 cylinder model codes.

10 Port location

Ports are located as shown below when viewing cylinder from head end (mounting end of double rod cylinder).

With some mounting styles, certain port locations cannot be selected due to interference with the mounting.

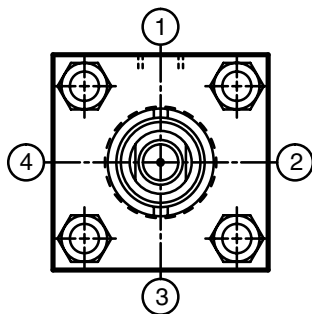

Code	Head	Cap
K-	1	1
L-	1	2
M-	1	3
N-	1	4
P-	2	1
R-	2	2
S-	2	3
T-	2	4
U-	3	1
V-	3	2
W-	3	3
Y-	3	4
1-	4	1
2-	4	2
3-	4	3
4-	4	4

(See detailed information on page NO TAG.)

11 Cushion location

Cushions are located as shown in item 10 when viewing cylinder from head end (mounting end of double rod cylinder). "-" in table indicates no cushion.

Code	Head	Cap
A-	-	-
B-	-	1
C-	-	2
D-	-	3
E-	-	4
F-	1	-
G-	2	-
H-	3	-
J-	4	-
K-	1	1
L-	1	2
M-	1	3
N-	1	4
P-	2	1
R-	2	2
S-	2	3
T-	2	4
U-	3	1
V-	3	2
W-	3	3
Y-	3	4
1-	4	1
2-	4	2
3-	4	3
4-	4	4

12, 13, 14 Stroke length

Stroke length can be from 001 mm to 999 mm.

15, 16 Enter applicable code for either:

Extra rod projection ("C" dimension)

This number is the extra rod projection from 00 mm through 99 mm.

- or -

Air bleed, gland drain or proximity switch location

Position 15 indicates air bleeds (H), gland drain (G) or proximity switches (P).

Position 16 indicates location of air bleeds, gland drain, or proximity switches as shown in item 10 when viewing cylinder from head end (mounting end of double rod cylinder). "-" in table indicates no air bleed or proximity switch.

Code	Head	Cap
B-	-	1
C-	-	2
D-	-	3
E-	-	4
F*	1	-
G*	2	-
H*	3	-
J*	4	-
K-	1	1
L-	1	2
M-	1	3
N-	1	4
P-	2	1
R-	2	2
S-	2	3
T-	2	4
U-	3	1
V-	3	2
W-	3	3
Y-	3	4
1-	4	1
2-	4	2
3-	4	3
4-	4	4

(See detailed information on page NO TAG.)

* Only these position codes should be used for the (G) gland drain option.

Model Codes for DIN 24554 Series TV Cylinders*

(All dimensions are in millimeters)

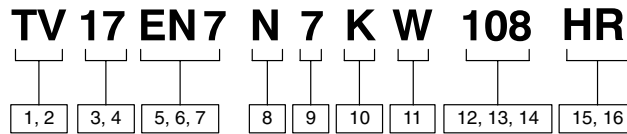

1, 2 Series
TV – DIN 24554 interchangeable hydraulic cylinder

3, 4 Mounting style

Vickers Code	Style	DIN Code
01 –	Side lug	MS2
07 –	Head rectangular	ME5
11 –	Spherical bearing	MP5
14 –	Cap rectangular	ME6
15 –	Intermediate trunnion	MT4

(See detailed information on page 7.)

5, 6, 7 Bore and rod diameters and rod end type

Code	Bore	Rod	Thread
BB0 –	25	12	M10 x 1,25
BE7 –	25	18	M10 x 1,25
2C0 –	32	14	M12 x 1,25
2G7 –	32	22	M12 x 1,25
CE0 –	40	18	M14 x 1,5
CJ7 –	40	28	M14 x 1,5
DG0 –	50	22	M16 x 1,5
DL7 –	50	36	M16 x 1,5
EJ0 –	63	28	M20 x 1,5
EN7 –	63	45	M20 x 1,5
GL0 –	80	36	M27 x 2
GQ7 –	80	56	M27 x 2
HN0 –	100	45	M33 x 2
HS7 –	100	70	M33 x 2
KQ0 –	125	56	M42 x 2
KU7 –	125	90	M42 x 2
LS0 –	160	70	M48 x 2
LW7 –	160	110	M48 x 2
NU0 –	200	90	M64 x 3
NZ7 –	200	140	M64 x 3

(See detailed information on pages NO TAG, NO TAG and NO TAG.)

8 Sealing System

Code Type
N – Normal
L – Low friction and water glycol
T – High temperature

(See detailed information on page NO TAG.)

9 Port type and size

Code Type
7 – BSPP to ISO 228/1

(See detailed information on page NO TAG.)

10 Port location

Ports are located as shown below when viewing cylinder from head end.

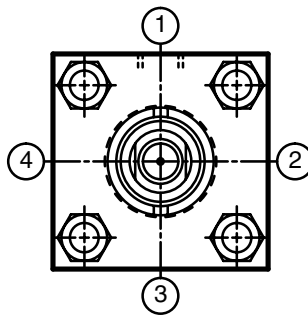

Code	Head	Cap
K –	1	1

(See detailed information on page NO TAG.)

11 Cushion location

Cushions are located as shown in item 10 when viewing cylinder from head end. “–” in table indicates no cushion.

Code	Head	Cap
A –	–	–
R –	2	2
W –	3	3

– Conforms to DIN 24554 for TV01 (MS2) mounting only.

12, 13, 14 Stroke length

Stroke length can be from 001 mm to 999 mm.

15, 16 Enter applicable code for either:

Extra rod projection (“C” dimension)

The two digits indicate extra rod projection from 00 mm through 99 mm.

– or –

Air bleed location

This number indicates location of air bleeds as shown in item 10 when viewing cylinder from head end.

Code	Head	Cap
HK –	1	1
HR –	2	2
HW –	3	3
H4 –	4	4

* See pages 4 and 5 for ISO 6020-2 cylinder model codes.

Mounting Style

Available Mountings

The variety of standard ISO and DIN mountings available in the Series TV gives you a broad selection to match the proper mount to your application. Vickers offers rigid mounts (including side lug, flange, and extended tie rod) and swivel mounts (including clevis and trunnion). The mounting styles that conform to DIN 24554 are shown on this page. Other ISO 6020-2 compatible mounts are shown on the next page. A guide to proper mount selection is provided on pages NO TAG through NO TAG. For custom mounts, enter "XX" for model code items 3 and 4 and give a detailed description with drawings. Series TV cylinders are available in all mounting styles listed.

Selecting the Proper Mounting

Just as the cylinder bore must be sized to provide the proper force for an application, a cylinder mounting that can absorb these application forces must also be specified. All Series TV mounts are designed to absorb the full rated force of the cylinder when properly applied. Note that the TV01 has been downrated to 70 bar and the TV04 and TV25 are downrated to 100 bar to minimize deflection on these non-centerline mounts. For applications where the motion is linear and parallel to the cylinder rod motion, a rigid mount is recommended. For curvilinear motion, a swivel mount should be chosen. The specifics of each application dictate the correct mounting style.

DIN Mounting Styles

TV01
Side lug
ISO MS2

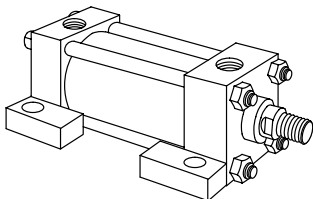

TV07
Head rectangular
DIN ME5

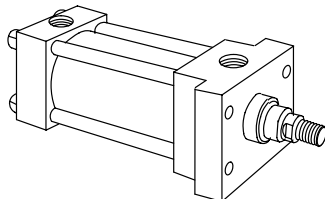

TV11
Spherical bearing
ISO MP5

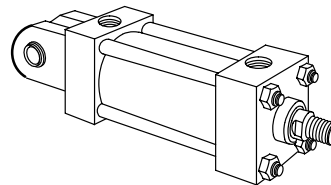

TV14
Cap rectangular
ISO ME6

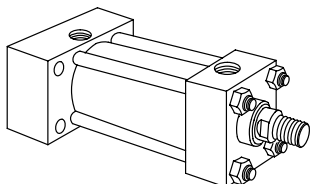

TV15
Intermediate trunnion
ISO MT4

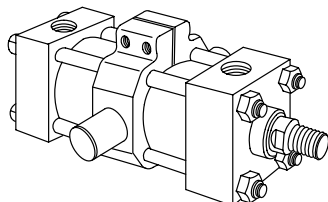

ISO Mounting Styles

TV01
Side lug
ISO MS2

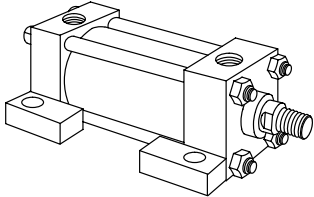

TV04
Keyed side lug

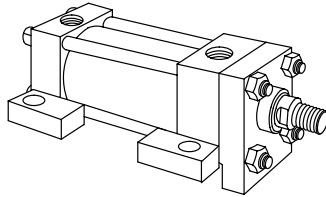

TV09
Head rectangular
ISO ME5

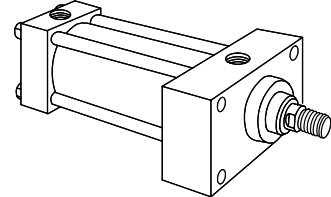

TV10
Cap clevis
ISO MP1

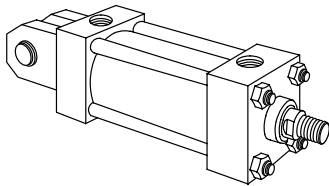

TV11
Spherical bearing
ISO MP5

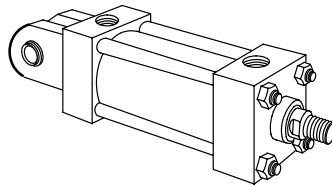

TV14
Cap rectangular
ISO ME6

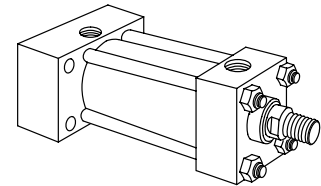

TV15
Intermediate trunnion
ISO MT4

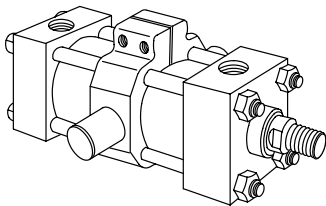

TV16
Cap trunnion
ISO MT2

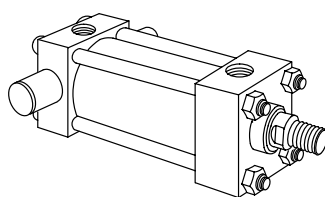

TV17
Head trunnion
ISO MT1

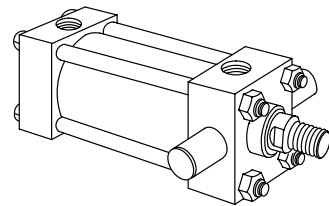

TV21
Cap extended tie rod
ISO MX2

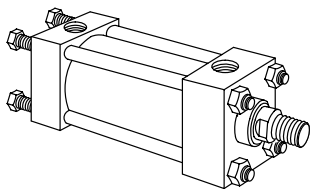

TV22
Head extended tie rod
ISO MX3

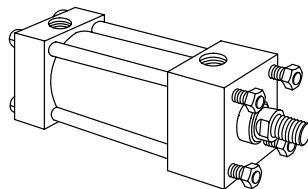

TV23
Both ends extended tie rod
ISO MX1

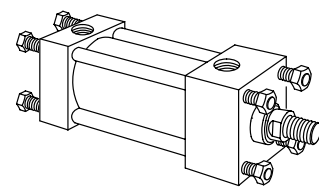

TV25
Double rod, side lug

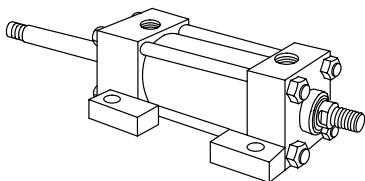

TV47
Cap fixed eye
ISO MP3

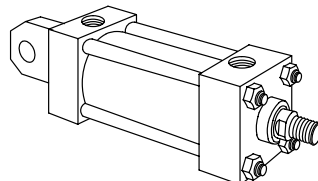

Series TV Mounting Styles & Installation Dimensions

TV01 Side Lug Mounts

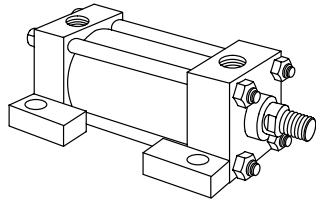

Side lug mounts are for moving loads along a flat guided surface as in a carriage along rails.

The mounting surface should be flat and parallel to the centerline of the piston rod. The load should be guided to

traverse along the centerline of the piston rod.

The frame on which the cylinder is mounted must be sufficiently rigid to resist bending moments.

NOTE

Limit operating pressure to 70 bar for minimum deflection. For strokes in excess of 600mm, see "Stop tube selection" on page NO TAG.

With unsupported loads, the bearing must absorb more force. For these applications, the larger available rod is recommended, and stop tubes should be considered.

Use high tensile socket head cap screws or hex head bolts tightened to the manufacturer's recommended torque.

For high shock applications, dowel pins or shear keys should be incorporated in the mounting design. For these applications, consider a keyed side lug mount, TV04.

For severe side load applications, consult your local Vickers sales engineer.

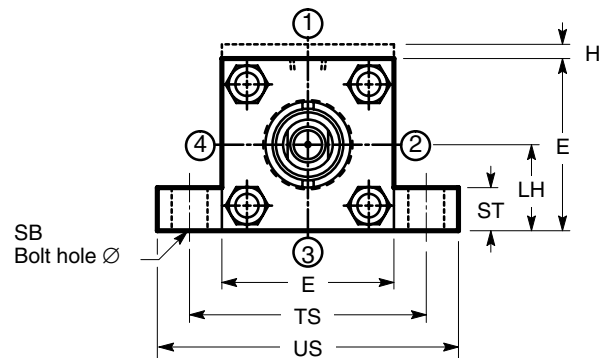
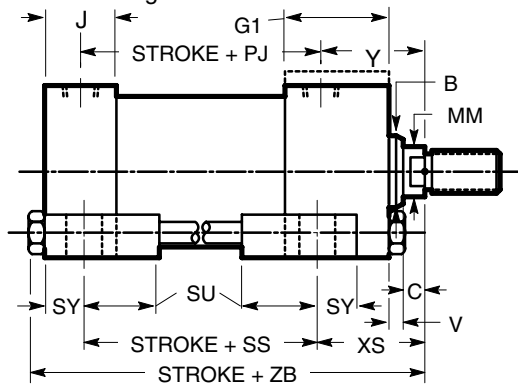

Bore	Rod MM	(f9) B	C	E	G1	H	J	V	Y	(h10) LH	PJ+	SB	SS+	ST	SU	SY	TS	US	XS	Max ZB+
25	12	24	10	40	50	5	25	6	50	19	53	6,6	73	9	19	8	54	72	33	121
	18	30	10	40	50	5	25	6	50	19	53	6,6	73	9	19	8	54	72	33	121
32	14	26	15	45	50	5	27	10	60	22	56	9	73	13	23	10	63	84	45	137
	22	34	17	45	50	5	27	9	60	22	56	9	73	13	23	10	63	84	45	137
40	18	30	20	63	57	-	38	6	62	31	73	11	98	13	23	10	83	103	45	166
	22	34	17	14	60	-	38	9	62	31	73	11	98	13	23	10	83	103	45	166
50	22	34	17	75	60	-	38	9	67	37	74	14	92	19	33	12	102	127	54	176
	28	42	20	17	60	-	38	5	67	37	74	14	92	19	33	12	102	127	54	176
63	28	42	27	90	60	-	38	5	71	44	80	18	86	26	40	17	124	161	65	185
	36	50	24	20	60	-	38	9	71	44	80	18	86	26	40	17	124	161	65	185
80	36	50	26	115	69	-	44	5	77	57	93	18	103	26	40	17	149	186	68	212
	45	60	23	23	69	-	44	9	77	57	93	18	103	26	40	17	149	186	68	212
100	45	60	30	130	73	-	44	5	82	63	101	26	102	32	51	22	172	216	79	225
	56	72	30	26	73	-	44	5	82	63	101	26	102	32	51	22	172	216	79	225
125	56	72	27	165	80	-	57	9	86	82	117	26	131	32	51	22	210	254	79	260
	70	88	26	26	80	-	57	9	86	82	117	26	131	32	51	22	210	254	79	260
160	70	88	26	205	88	-	57	7	86	101	130	33	130	38	63	29	260	318	86	279
	90	108	26	133	88	-	57	6	86	101	130	33	130	38	63	29	260	318	86	279
200	90	108	26	245	107	-	76	6	98	122	165	39	172	44	73	35	311	381	92	336
	110	133	26	163	107	-	76	6	98	122	165	39	172	44	73	35	311	381	92	336

TV04 Keyed Side Lug Mounts

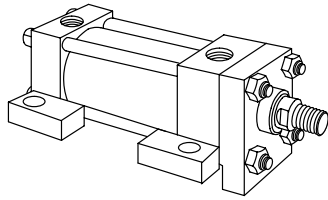

Keyed side lug mounts are for moving loads along a flat guided surface as in a carriage along rails.

The mounting surface should be flat and parallel to the centerline of the piston rod. The load should be guided to traverse along the centerline of the piston rod.

The frame on which the cylinder is mounted must be sufficiently rigid to resist bending moments.

NOTE

Limit operating pressure to 100 bar for minimum deflection. For strokes in excess of 600mm, see "Stop tube selection" on page NO TAG.

With unsupported loads, the bearing must absorb more force. For these applications, the larger available rod is recommended, and stop tubes should be considered.

Use high tensile socket head cap screws or hex head bolts tightened to the manufacturer's recommended torque.

For severe side load applications, consult your local Vickers sales engineer.

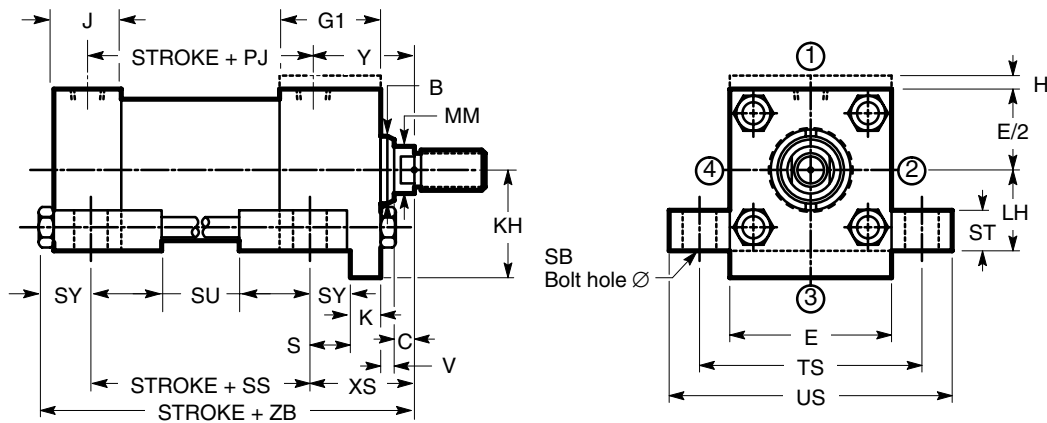

Bore	Rod MM	(f9) B	C	E	G1	H	J	K	S	V	Y	Max KH	(h10) LH	PJ+	SB	SS+	ST	SU	SY	TS	US	XS	Max ZB+
25	12	24	10	40	50	5	25	8	10	6	50	19	19	53	6,6	73	9	19	8	54	72	33	121
	18	30	10	40	50	5	25	8	10	6	50	19	19	53	6,6	73	9	19	8	54	72	33	121
32	14	26	15	45	50	5	27	8	12	10	60	22	22	56	9	73	13	23	10	63	84	45	137
	22	34	17	45	50	5	27	8	12	9	60	22	22	56	9	73	13	23	10	63	84	45	137
40	18	30	20	63	57	-	38	8	12	6	62	31	31	73	11	98	13	23	10	83	103	45	166
	22	9																					
	28	12																					
50	22	34	17	75	60	-	38	14	15	5	67	37	37	74	14	92	19	33	12	102	127	54	176
	28	9																					
	36	9																					
63	28	42	27	90	60	-	38	14	19	5	71	44	44	80	18	86	26	40	17	124	161	65	185
	36	9																					
	45	12																					
80	36	50	26	115	69	-	44	18	19	5	77	57	57	93	18	103	26	40	17	149	186	68	212
	45	9																					
	56	9																					
100	45	60	30	130	73	-	44	22	22	5	82	63	63	101	26	102	32	51	22	172	216	79	225
	56	5																					
	70	9																					
125	56	72	27	165	80	-	57	22	22	9	86	82	82	117	26	131	32	51	22	210	254	79	260
	70	9																					
	90	108																					
160	70	88	26	205	88	-	57	25	29	7	86	101	101	130	33	130	38	63	29	260	318	86	279
	90	6																					
	110	6																					
200	90	108	26	245	107	-	76	25	35	6	98	122	122	165	39	172	44	73	35	311	381	92	336
	110	6																					
	140	163																					

TV07 Head Rectangular Mounts (DIN ME5)

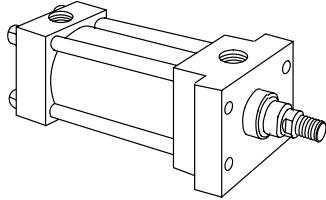

These mounts are ideal for straight line force transfer applications in which the cylinder is used in tension (pulling).

The mounting surface should be flat, and the rod end cartridge should be piloted into it.

The frame on which the cylinder is mounted must be sufficiently rigid to resist bending moments.

NOTE

For strokes in excess of 600mm, see "Stop tube selection" on page NO TAG.

The force of the load should be perpendicular to the mounting surface

and parallel to the centerline of the piston rod. For eccentric loads, the larger of the two available rods in each bore size is recommended. Stop tubes should also be considered.

The head rectangular mounts (TV07 and TV09) are recommended for heavy duty applications.

Use high tensile socket head cap screws or hex head bolts tightened to the manufacturer's recommended torque.

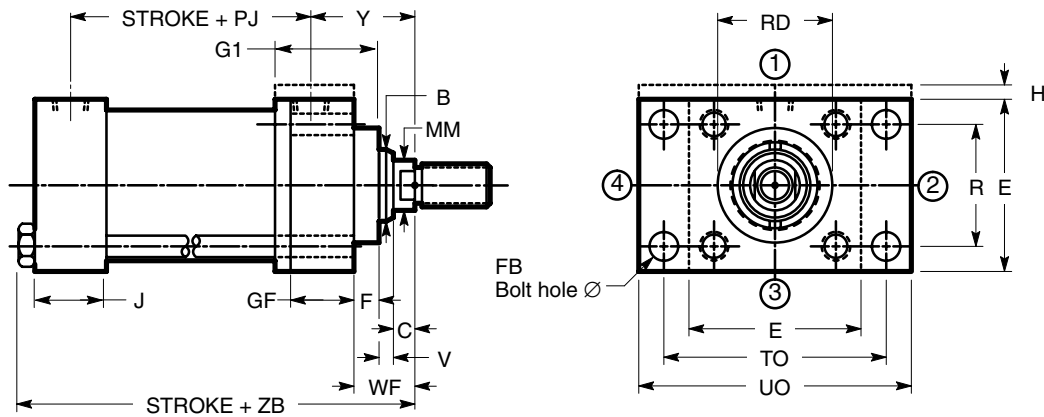

Bore	Rod MM	(f9) B	C	E	Max F	G1	GF	H	J	R	V	Y	FB	PJ+	(f8) RD	TO	Max UO	WF	Max ZB+
25	12	24	10	40	10	50	25	5	25	27	6	50	5,5	53	38	51	65	25	121
	18	30	10	40	10	50	25	5	25	27	6	50	5,5	53	38	51	65	25	121
32	14	26	15	45	10	50	25	5	27	33	10	60	6,6	56	42	58	70	35	137
	22	34	17	45	10	50	25	5	27	33	9	60	6,6	56	42	58	70	35	137
40	18	30	20	63	10	57	38	-	38	41	6	62	11	73	62	87	110	35	166
	22	34	17					9											
	28	42	14					12											
50	22	34	17	75	16	60	38	-	38	52	9	67	14	74	74	105	130	41	176
	28	42	20					5											
	36	50	17					9											
63	28	42	27	90	16	60	38	-	38	65	5	71	14	80	75	117	145	48	185
	36	50	24					9			82								
	45	60	20					12			88								
80	36	50	26	115	20	69	45	-	44	83	5	77	18	93	82	149	180	51	212
	45	60	23					9			92								
	56	72	23					9			105								
100	45	60	30	130	22	73	45	-	44	97	5	82	18	101	92	162	200	57	225
	56	72	30					5			105								
	70	88	26					9			125								
125	56	72	27	165	22	80	58	-	57	126	9	86	22	117	105	208	250	57	260
	70	88	26					9			125								
	90	108	26					9			150								
160	70	88	26	205	25	88	58	-	57	155	7	86	26	130	125	253	300	57	279
	90	108	26					6			150								
	110	133	26					6			170								
200	90	108	26	245	27	107	76	-	76	190	6	98	33	165	150	300	360	57	336
	110	133	26					6			170								
	140	163	26					-			210								

TV09 Head Rectangular Mounts (ISO ME5)

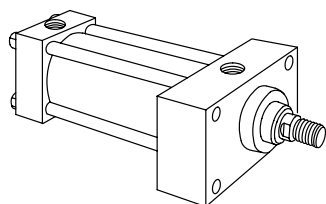

These mounts are ideal for straight line force transfer applications in which the cylinder is used in tension (pulling).

The mounting surface should be flat, and the rod end cartridge should be piloted into it.

The frame on which the cylinder is mounted must be sufficiently rigid to resist bending moments.

NOTE

For strokes in excess of 600mm, see "Stop tube selection" on page NO TAG.

The force of the load should be perpendicular to the mounting surface

and parallel to the centerline of the piston rod. For eccentric loads, the larger of the two available rods in each bore size is recommended. Stop tubes should also be considered.

The head rectangular mounts (TV07 and TV09) are recommended for heavy duty applications.

Use high tensile socket head cap screws or hex head bolts tightened to the manufacturer's recommended torque.

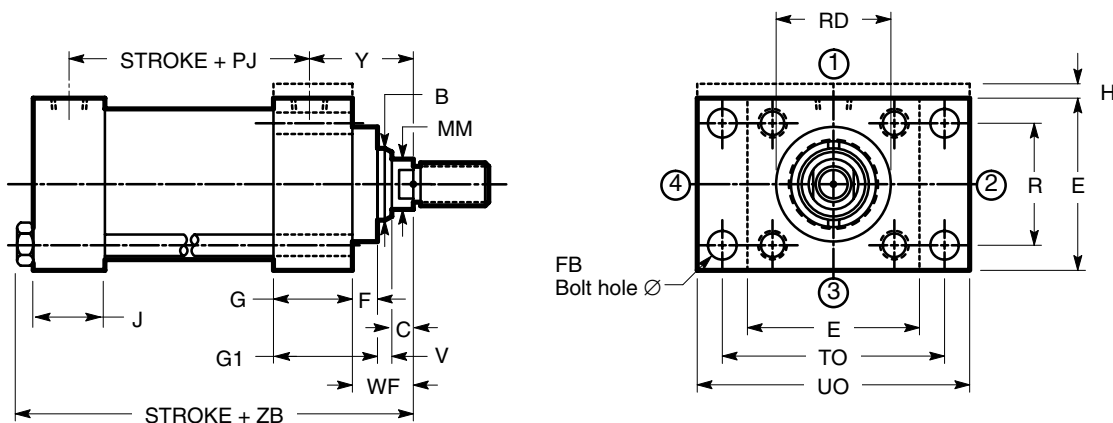

Bore	Rod MM	(f9) B	C	E	Max F	G	G1	H	J	R	V	Y	FB	PJ+	(f8) RD	TO	Max UO	WF	Max ZB+
25	12	24	10	40	10	40	50	5	25	27	6	50	5,5	53	38	51	65	25	121
	18	30	10	40	10	40	50	5	25	27	6	50	5,5	53	38	51	65	25	121
32	14	26	15	45	10	40	50	5	27	33	10	60	6,6	56	42	58	70	35	137
	22	34	17	45	10	40	50	5	27	33	9	60	6,6	56	42	58	70	35	137
40	18	30	20	63	10	47	57	-	38	41	6	62	11	73	62	87	110	35	166
	22	34	17								9								
	28	42	14								12								
50	22	34	17	75	16	44	60	-	38	52	9	67	14	74	74	105	130	41	176
	28	42	20								5								
	36	50	17								9								
63	28	42	27	90	16	44	60	-	38	65	5	71	14	80	75	117	145	48	185
	36	50	24								9				82				
	45	60	20								12				88				
80	36	50	26	115	20	49	69	-	44	83	5	77	18	93	82	149	180	51	212
	45	60	23								9				92				
	56	72	23								9				105				
100	45	60	30	130	22	51	73	-	44	97	5	82	18	101	92	162	200	57	225
	56	72	30								5				105				
	70	88	26								9				125				
125	56	72	27	165	22	58	80	-	57	126	9	86	22	117	105	208	250	57	260
	70	88	26								9				125				
	90	108	26								9				150				
160	70	88	26	205	25	58	88	-	57	155	7	86	26	130	125	253	300	57	279
	90	108	26								6				150				
	110	133	26								6				170				
200	90	108	26	245	27	76	107	-	76	190	6	98	33	165	150	300	360	57	336
	110	133	26								6				170				
	140	163	26								6				210				

TV10 Clevis Mount (ISO MP1)

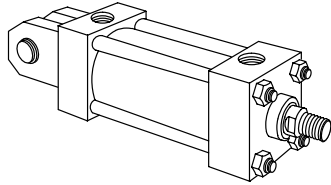

These mounts can be used both in compression (push) and tension (pull). Care must be exercised to prevent rod buckling in compression applications with long strokes. See page NO TAG for stroke limitations.

NOTE

For strokes in excess of 500mm, see "Stop tube selection" on page NO TAG.

The centerline of the machine member that attaches to the swivel pin must be perpendicular to the centerline of the piston rod and the curved path must be in one plane only. Any misalignment will cause excess side loading on the bearing and piston. This will lead to premature failure. For applications with small amounts of misalignment, consider the spherical bearing mount, TV11.

These mounts are for applications in which the machine member travels in a curved path within one plane.

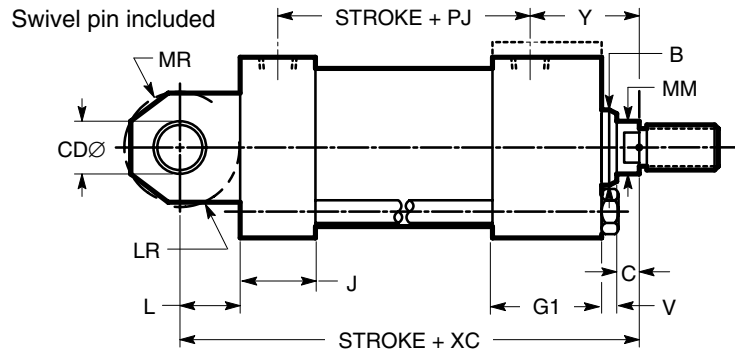
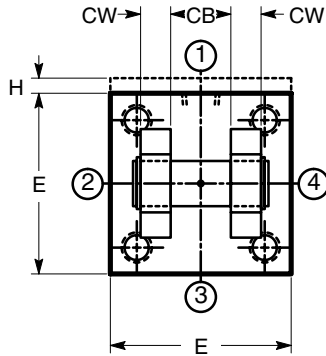

Bore	Rod MM	(f9) B	C	E	G1	H	J	Min L	V	Y	(A16) CB	(f8) CD	Max CW	Min LR	Max MR	PJ+	XC+
25	12	24	10	40	50	5	25	13	6	50	12	10	8,5	12	12	53	127
	18	30	10	40	50	5	25	13	6	50	12	10	8,5	12	12	53	127
32	14	26	15	45	50	5	27	19	10	60	16	12	10,5	17	17	56	147
	22	34	17	45	50	5	27	19	9	60	16	12	10,5	17	17	56	147
40	18	30	20	63	57	-	38	19	6	62	20	14	12,5	17	17	73	172
	22	34	17						9								
	28	42	14						12								
50	22	34	17	75	60	-	38	32	9	67	30	20	18	29	29	74	191
	28	42	20						5								
	36	50	17						9								
63	28	42	27	90	60	-	38	32	5	71	30	20	18	29	29	80	200
	36	50	24						9								
	45	60	20						12								
80	36	50	26	115	69	-	44	39	5	77	40	28	23,5	34	34	93	229
	45	60	23						9								
	56	72	23						9								
100	45	60	30	130	73	-	44	54	5	82	50	36	28,5	50	50	101	257
	56	72	30						5								
	70	88	26						9								
125	56	72	27	165	80	-	57	57	9	86	60	45	34,5	53	53	117	289
	70	88	26						9								
	90	108	26						9								
160	70	88	26	205	88	-	57	63	7	86	70	56	39,5	59	59	130	308
	90	108	26						6								
	110	133	26						6								
200	90	108	26	245	107	-	76	82	6	98	80	70	44,5	78	78	165	381
	110	133	26						6								
	140	163	26						6								

TV11 Spherical Bearing Mount

(ISO MP5)

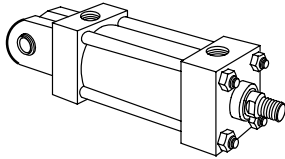

This mount is for applications in which the machine member travels in a curved path in one plane where some misalignment is unavoidable. The amount of allowable misalignment can be calculated.

This mount can be used both in compression (push) and tension (pull) applications. Care must be exercised to prevent rod buckling in compression

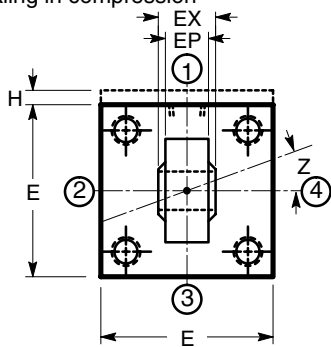

applications with long strokes. See page NO TAG for stroke limitations.

NOTE

For strokes in excess of 500mm, see "Stop tube selection" on page NO TAG.

Maximum radial static and dynamic bearing loads must not exceed the recommended ratings shown in the following table.

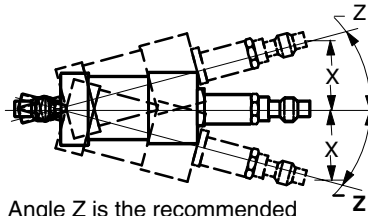

Angle Z is the recommended maximum angle of misalignment.

To find the maximum recommended X distance, multiply the distance between pivot mounting holes (see TV11 dimensional drawing) by the tangent of angle Z.

Bore \varnothing (mm)	Mounting Hole \varnothing (mm)	Static Radial Load Rating (KN)
25	12	8
32	16	12,5
40	20	20
50	25	32
63	30	50
80	40	80
100	50	125
125	60	200
160	80	320
200	100	500

See page NO TAG for spherical rod end bearing accessory.

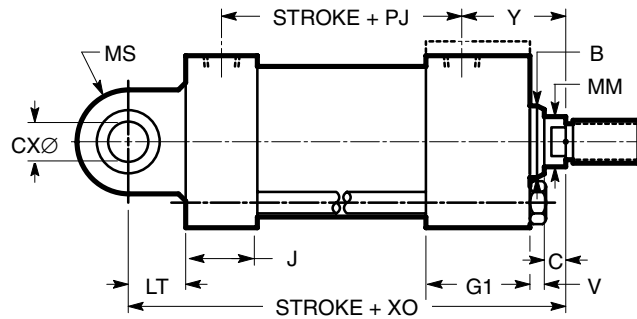

Bore	Rod MM	(f9) B	C	E	G1	H	J	V	Y	Min Z	CX	EP	EX	Min LT	Max MS	PJ+	XC+
25	12	24	10	40	50	5	25	6	50	3°	12 +0,00/-0,008	8	10 +0,00/-0,12	16	20	53	130
	18	30	10	40	50	5	25	6	50	3°	12 +0,00/-0,008	8	10 +0,00/-0,12	16	20	53	130
32	14	26	15	45	50	5	27	10	60	3°	16 +0,00/-0,008	11	14 +0,00/-0,12	20	23	56	148
	22	34	17	45	50	5	27	9	60	3°	16 +0,00/-0,008	11	14 +0,00/-0,12	20	23	56	148
40	18	30	20	63	57	-	38	6	62	3°	20 +0,00/-0,012	13	16 +0,00/-0,12	25	29	73	178
	22	17	9														
	28	14	12														
50	22	34	17	75	60	-	38	9	67	3°	25 +0,00/-0,012	17	20 +0,00/-0,12	31	33	74	190
	28	20	5														
	36	17	9														
63	28	42	27	90	60	-	38	5	71	3°	30 +0,00/-0,012	19	22 +0,00/-0,12	38	40	80	206
	36	24	9														
	45	20	12														
80	36	50	26	115	69	-	44	5	77	3°	40 +0,00/-0,012	23	28 +0,00/-0,12	48	50	93	238
	45	23	9														
	56	23	9														
100	45	60	30	130	73	-	44	5	82	3°	50 +0,00/-0,012	30	35 +0,00/-0,12	58	62	101	261
	56	30	5														
	70	26	9														
125	56	72	27	165	80	-	57	9	86	3°	60 +0,00/-0,015	38	44 +0,00/-0,15	72	80	117	304
	70	26	-														
	90	26	-														
160	70	88	26	205	88	-	57	7	86	3°	80 +0,00/-0,015	47	55 +0,00/-0,15	92	100	130	337
	90	108	6														
	110	133	6														
200	90	108	26	245	107	-	76	6	98	3°	100 +0,00/-0,020	57	70 +0,00/-0,20	116	120	165	415
	110	133	-														
	140	163	-														

TV14 Cap Rectangular Mounts (ISO ME6)

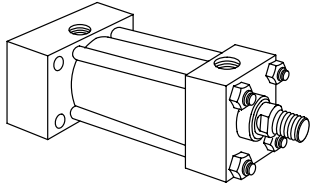

These mounts are for straight line force transfer applications in which the cylinder is used in compression (pushing) and tension (pulling) applications.

The mounting surface should be flat and perpendicular to the force of the load.

The frame on which the cylinder is mounted must be sufficiently rigid to resist bending moments.

The cap rectangular mount (TV14) is recommended for heavy duty applications.

NOTE

For strokes in excess of 600mm, see "Stop tube selection" on page NO TAG.

Use high tensile socket head cap screws or hex head bolts tightened to the manufacturer's recommended torque value.

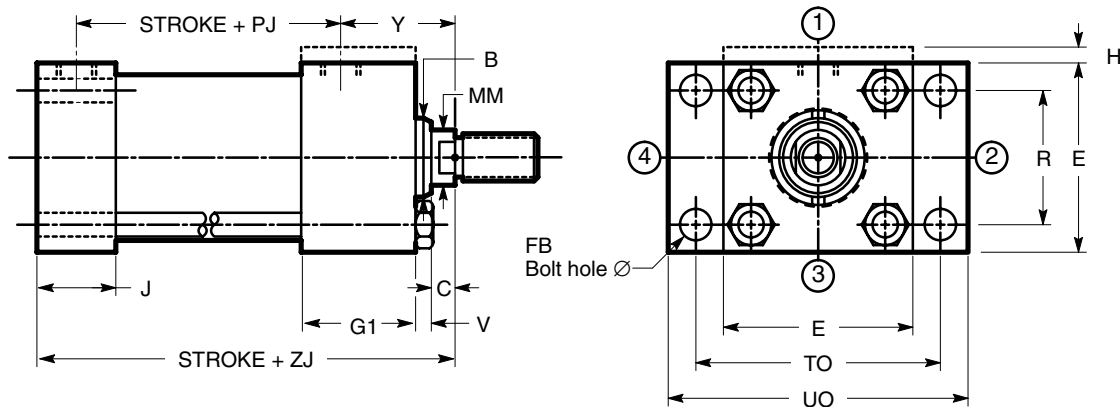

Bore	Rod MM	(f9) B	C	E	G1	H	J	R	V	Y	FB	PJ+	TO	Max UO	ZJ+
25	12	24	10	40	50	5	25	27	6	50	5,5	53	51	65	114
	18	30	10	40	50	5	25	27	6	50	5,5	53	51	65	114
32	14	26	15	45	50	5	27	33	10	60	6,6	56	58	70	128
	22	34	17	45	50	5	27	33	9	60	6,6	56	58	70	128
40	18	30	20	63	57	-	38	41	6	62	11	73	87	110	153
	22	34	17						9						
	28	42	14						12						
50	22	34	17	75	60	-	38	52	9	67	14	74	105	130	159
	28	42	20						5						
	36	50	17						9						
63	28	42	27	90	60	-	38	65	5	71	14	80	117	145	168
	36	50	24						9						
	45	60	20						12						
80	36	50	26	115	69	-	44	83	5	77	18	93	149	180	190
	45	60	23						9						
	56	72	23						9						
100	45	60	30	130	73	-	44	97	5	82	18	101	162	200	203
	56	72	30						5						
	70	88	26						9						
125	56	72	27	165	80	-	57	126	9	86	22	117	208	250	232
	70	88	26						9						
	90	108	26						9						
160	70	88	26	205	88	-	57	155	7	86	26	130	253	300	245
	90	108							6						
	110	133							6						
200	90	108	26	245	107	-	76	190	6	98	33	165	300	360	299
	110	133							6						
	140	163							6						

TV15 Intermediate Trunnion Mount

(ISO MT4)

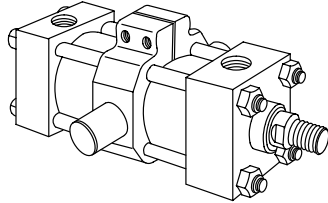

The Intermediate Trunnion Mount is for longer stroke applications in which the machine member travels in a curved path in one plane.

On special orders, the trunnion can be located anywhere along the body.

This mount can be used both in compression (push) and tension (pull) applications.

NOTE

For strokes in excess of 500mm, see "Stop tube selection" on page NO TAG.

It is recommended that rigidly mounted pillow blocks with bearings at least as long as the trunnion pins be used. The pillow blocks should be installed as close to the shoulder of the trunnion as possible.

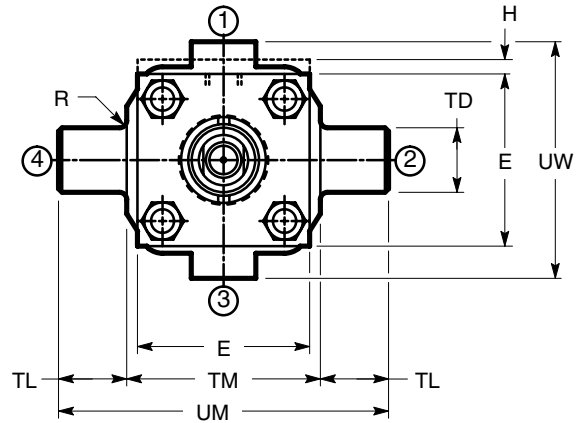
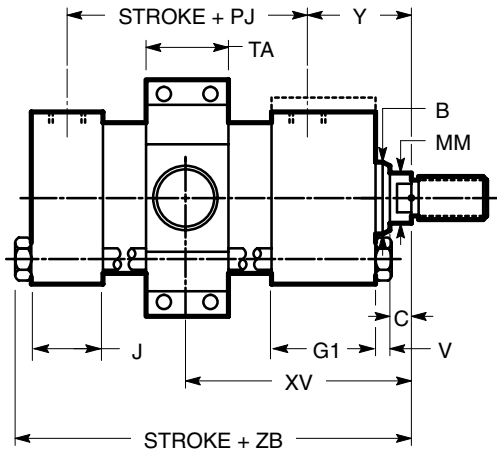

Bore	Rod MM	(f9) B	C	E	G1	H	J	R	V	Y	PJ+	TA	TD	TL	TM	UM	Max UW	Min	XV* Std*	Max+	Max ZB+
25	12	24	10	40	50	5	25	1,5	6	50	53	17,5	12 -0,016/-0,043	10	48	68	63	82	77	72	121
	18	30	10	40	50	5	25	1,5	6	50	53	17,5	12 -0,016/-0,043	10	48	68	63	82	77	72	121
32	14	26	15	45	50	5	27	1,5	10	60	56	20,0	16 -0,016/-0,043	12	55	79	75	96	89	82	137
	22	34	17	45	50	5	27	1,5	9	60	56	20,0	16 -0,016/-0,043	12	55	79	75	96	89	82	137
40	18	30	20	63	57	-	38	2,0	6	62	73	29,0	20 -0,020/-0,053	16	76	108	92	107	98	88	166
	22	34	17	63	57	-	38	2,0	9	62	73	29,0	20 -0,020/-0,053	16	76	108	92	107	98	88	166
50	28	36	20	75	60	-	38	2,0	9	67	74	38,5	25 -0,020/-0,053	20	89	129	112	117	104	90	176
	36	42	17	75	60	-	38	2,0	5	67	74	38,5	25 -0,020/-0,053	20	89	129	112	117	104	90	176
63	28	42	27	90	60	-	38	2,0	5	71	80	42,5	32 -0,025/-0,064	25	100	150	126	132	112	91	185
	36	50	24	90	60	-	38	2,0	9	71	80	42,5	32 -0,025/-0,064	25	100	150	126	132	112	91	185
80	36	50	26	115	69	-	44	2,0	5	77	93	51,0	40 -0,025/-0,064	32	127	191	160	147	123	99	212
	45	60	23	115	69	-	44	2,0	9	77	93	51,0	40 -0,025/-0,064	32	127	191	160	147	123	99	212
100	45	60	30	130	73	-	44	2,0	5	82	101	66,0	50 -0,025/-0,064	40	140	220	180	158	133	107	225
	56	72	30	130	73	-	44	2,0	5	82	101	66,0	50 -0,025/-0,064	40	140	220	180	158	133	107	225
125	56	72	27	165	80	-	57	2,0	9	86	117	84,0	63 -0,030/-0,076	50	178	278	215	180	145	109	260
	70	88	26	165	80	-	57	2,0	9	86	117	84,0	63 -0,030/-0,076	50	178	278	215	180	145	109	260
160	70	88	26	205	88	-	57	2,0	7	86	130	106	80 -0,030/-0,076	63	215	341	260	198	154	104	279
	90	108	26	205	88	-	57	2,0	6	86	130	106	80 -0,030/-0,076	63	215	341	260	198	154	104	279
200	90	108	26	245	107	-	76	2,0	6	98	165	133	100 -0,036/-0,090	80	279	439	355	226	181	130	336
	110	133	26	245	107	-	76	2,0	6	98	165	133	100 -0,036/-0,090	80	279	439	355	226	181	130	336

* The standard XV dimension is Stroke/2 + XV (std.) unless otherwise specified.
+ Plus stroke

TV16 Cap Trunnion Mounts (ISO MT2)

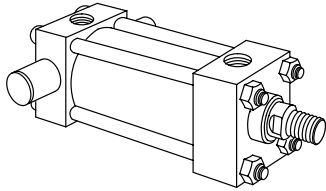

Either mount can be used both in compression (push) and tension (pull) applications. When used in compression applications, head trunnion mounts provide a longer maximum stroke than cap trunnion mounts.

NOTE

For strokes in excess of 500mm, see "Stop tube selection" on page NO TAG.

an extremely tight fit to the mating machine member and permit curvilinear motion.

It is recommended that rigidly mounted pillow blocks with bearings at least as long as the trunnion pins be used. The pillow blocks should be installed as close to the shoulder of the trunnion as possible.

These mounts are for applications in which the machine member travels in a curved path in one plane.

The trunnion pins are an integral part of the head and can be sleeved to provide

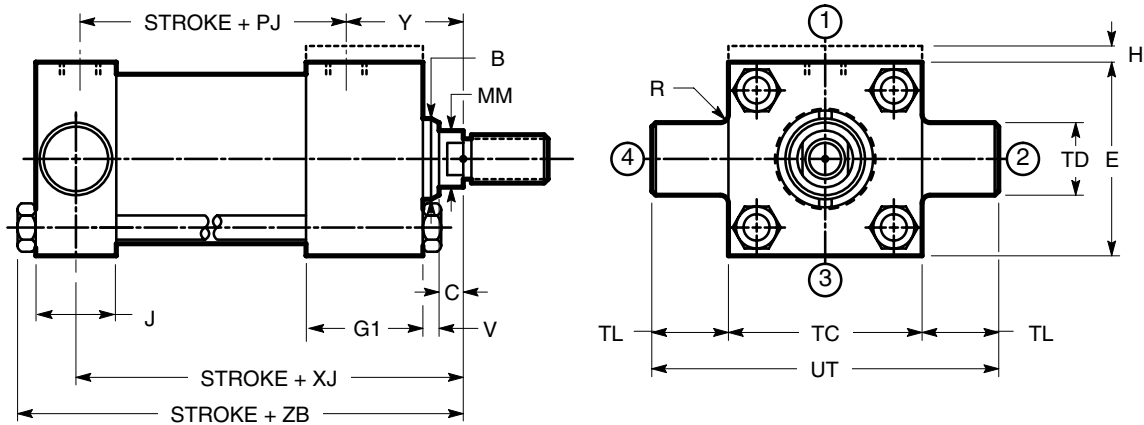

Bore	Rod MM	(f9) B	C	E	G1	H	J	Max R	V	Y	PJ+	(h14) TC	(f8) TD	TL	(h15) UT	XJ+	Max ZB+
25	12	24	10	40	50	5	25	1,1	6	50	53	38	12	10	58	101	121
	18	30	10	40	50	5	25	1,1	6	50	53	38	12	10	58	101	121
32	14	26	15	45	50	5	27	1,1	10	60	56	44	16	12	68	115	137
	22	34	17	45	50	5	27	1,1	9	60	56	44	16	12	68	115	137
40	18	30	20	63	57	-	38	1,1	6	62	73	63	20	16	95	134	166
	22	34	17						9								
	28	42	14						12								
50	22	34	17	75	60	-	38	1,1	9	67	74	76	25	20	116	140	176
	28	42	20						5								
	36	50	17						9								
63	28	42	27	90	60	-	38	1,9	5	71	80	89	32	25	139	149	185
	36	50	24						9								
	45	60	20						12								
80	36	50	26	115	69	-	44	1,9	5	77	93	114	40	32	178	168	212
	45	60	23						9								
	56	72	23						9								
100	45	60	30	130	73	-	44	1,9	5	82	101	127	50	40	207	287	225
	56	72	30						5								
	70	88	26						9								
125	56	72	27	165	80	-	57	1,9	9	86	117	165	63	50	265	209	260
	70	88	26						9								
	90	108	26						9								
160	70	88	26	205	88	-	57	1,9	7	86	130	203	80	63	329	230	279
	90	108							6								
	110	133							6								
200	90	108	26	245	107	-	76	1,9	6	98	165	241	100	80	401	276	336
	110	133							6								
	140	163							6								

TV17 Head Trunnion Mounts (ISO MT1)

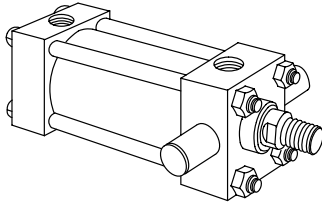

These mounts are for applications in which the machine member travels in a curved path in one plane.

Either mount can be used both in compression (push) and tension (pull) applications. When used in compression applications, head trunnion mounts provide a longer maximum stroke than cap trunnion mounts.

NOTE

For strokes in excess of 500mm, see "Stop tube selection" on page NO TAG.

The trunnion pins are an integral part of the head and can be sleeved to provide

an extremely tight fit to the mating machine member and permit curvilinear motion.

It is recommended that rigidly mounted pillow blocks with bearings at least as long as the trunnion pins be used. The pillow blocks should be installed as close to the shoulder of the trunnion as possible.

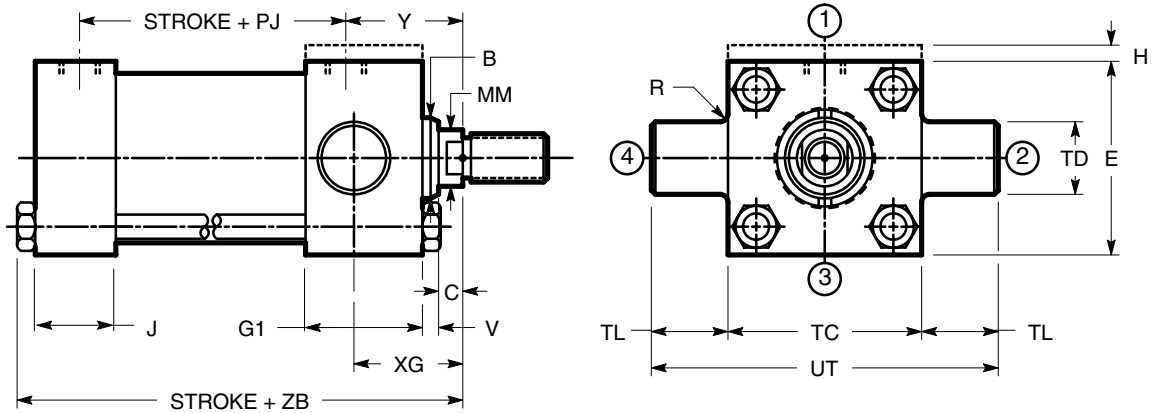

Bore	Rod MM	(f9) B	C	E	G1	H	J	Max R	V	Y	PJ+	(h14) TC	(f8) TD	TL	(h15) UT	XG	Max ZB+
25	12	24	10	40	50	5	25	1,1	6	50	53	38	12	10	58	44	121
	18	30	10	40	50	5	25	1,1	6	50	53	38	12	10	58	44	121
32	14	26	15	45	50	5	27	1,1	10	60	56	44	16	12	68	54	137
	22	34	17	45	50	5	27	1,1	9	60	56	44	16	12	68	54	137
40	18	30	20	63	57	-	38	1,1	6	62	73	63	20	16	95	57	166
	22	34	17						9								
	28	42	14						12								
50	22	34	17	75	60	-	38	1,1	9	67	74	76	25	20	116	64	176
	28	42	20						5								
	36	50	17						9								
63	28	42	27	90	60	-	38	1,9	5	71	80	89	32	25	139	70	185
	36	50	24						9								
	45	60	20						12								
80	36	50	26	115	69	-	44	1,9	5	77	93	114	40	32	178	76	212
	45	60	23						9								
	56	72	23						9								
100	45	60	30	130	73	-	44	1,9	5	82	101	127	50	40	207	71	225
	56	72	30						5								
	70	88	26						9								
125	56	72	27	165	80	-	57	1,9	9	86	117	165	63	50	265	75	260
	70	88	26						9								
	90	108	26						9								
160	70	88	26	205	88	-	57	1,9	7	86	130	203	80	63	329	75	279
	90	108							6								
	110	133							6								
200	90	108	26	245	107	-	76	1,9	6	98	165	241	100	80	401	85	336
	110	133							6								
	140	163							6								

TV21 Cap Extended Tie Rod Mounts (ISO MX2)

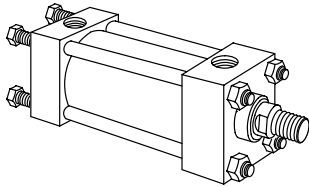

These mounts are for straight line force transfer applications. The cap extended tie rod mount is recommended for compression (pushing) applications.

The mounting surface should be flat and the frame on which the cylinder is mounted must be sufficiently rigid to resist bending moments.

Once fitted into the application framework, the nuts which are provided should be torqued to the values listed in the table (right).

NOTE

For strokes in excess of 600mm, see "Stop tube selection" on page NO TAG.

Tie Rod Diameters & Torque Values

Diameters and torque values in the following table apply to all mounting styles.

Bore ∅ (mm)	Tie Rods ∅ (mm)	Torque* (Nm)
25	5	5,5
32	6	11
40	8	19
50	12	45
63	12	68
80	16	140
100	16	205
125	22	460
160	27	935
200	30	1520

* Recommended torque values using MoS₂ lubricant with 0,12 coefficient of friction.

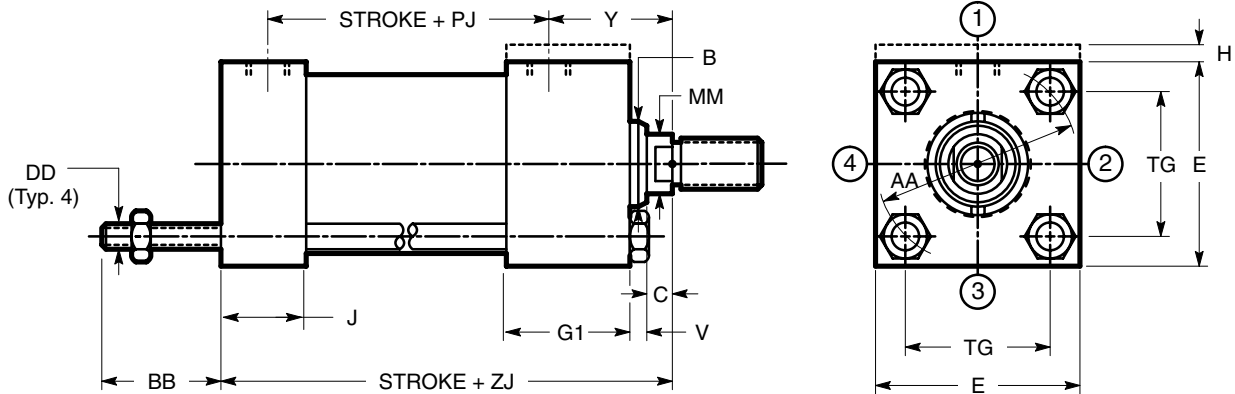

Bore	Rod MM	(f9) B	C	E	G1	H	J	V	Y	AA	BB	DD	PJ+	TG	ZJ+
25	12	24	10	40	50	5	25	6	50	40	19	M5 x 0,8	53	28,3	114
	18	30	10	40	50	5	25	6	50	40	19	M5 x 0,8	53	28,3	114
32	14	26	15	45	50	5	27	10	60	47	24	M6 x 1	56	33,2	128
	22	34	17	45	50	5	27	9	60	47	24	M6 x 1	56	33,2	128
40	18	30	20	63	57	-	38	6	62	59	35	M8 x 1	73	41,7	153
	22	34	17					9							
	28	42	14					12							
50	22	34	17	75	60	-	38	9	67	74	46	M12 x 1,25	74	52,3	159
	28	42	20					5							
	36	50	17					9							
63	28	42	27	90	60	-	38	5	71	91	46	M12 x 1,25	80	64,3	168
	36	50	24					9							
	45	60	20					12							
80	36	50	26	115	69	-	44	5	77	117	59	M16 x 1,5	93	82,7	190
	45	60	23					9							
	56	72	23					9							
100	45	60	30	130	73	-	44	5	82	137	59	M16 x 1,5	101	96,9	203
	56	72	30					5							
	70	88	26					9							
125	56	72	27	165	80	-	57	9	86	178	81	M22 x 1,5	117	125,9	232
	70	88	26					-							
	90	108	26												
160	70	88	26	205	88	-	57	7	86	219	92	M27 x 2	130	154,9	245
	90	108	-					6							
	110	133						6							
200	90	108	26	245	107	-	76	6	98	269	115	M30 x 2	165	190,2	299
	110	133	-												
	140	163													

TV22 Head Extended Tie Rod Mounts (ISO MX3)

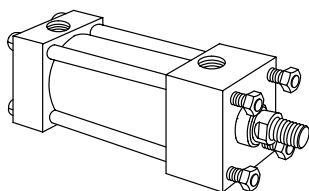

These mounts are for straight line force transfer applications. The head extended

tie rod mount is recommended for tension (pulling) applications.

The mounting surface should be flat and the frame on which the cylinder is mounted must be sufficiently rigid to resist bending moments.

On head mount applications, the cartridge provides a pilot diameter to align the rod in the mounting frame.

Once fitted into the application framework, the nuts which are provided should be torqued to the values listed in the table on the previous page.

NOTE

For strokes in excess of 600mm, see "Stop tube selection" on page NO TAG.

The force on the rod should be perpendicular to the mounting surface and coincide with the centerline of the piston rod. For eccentric loads, the larger of the two available rods in each bore size is recommended. Stop tubes should also be considered.

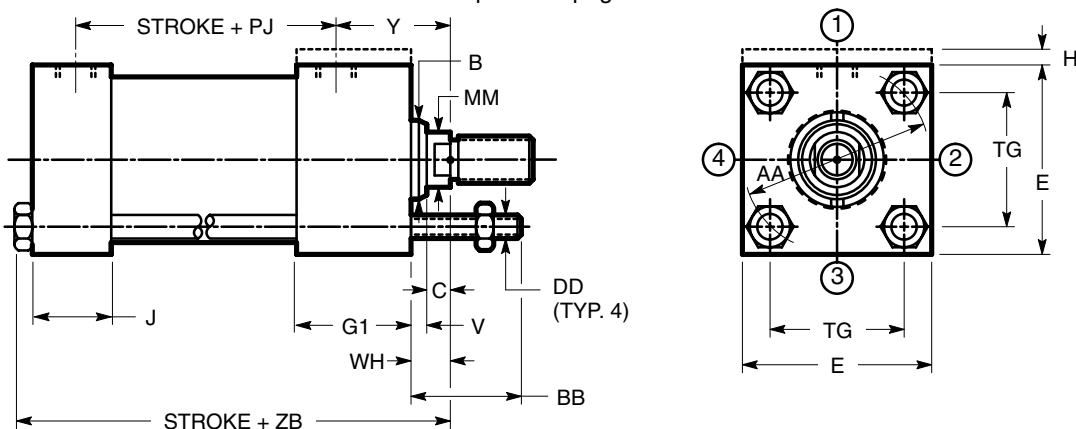

Bore	Rod MM	(f9) B	C	E	G1	H	J	V	Y	AA	BB	DD	PJ+	TG	WH	Max ZB+
25	12	24	10	40	50	5	25	6	50	40	19	M5 x 0,8	53	28,3	15	121
	18	30	10	40	50	5	25	6	50	40	19	M5 x 0,8	53	28,3	15	121
32	14	26	15	45	50	5	27	10	60	47	24	M6 x 1	56	33,2	25	137
	22	34	17	45	50	5	27	9	60	47	24	M6 x 1	56	33,2	25	137
40	18	30	20	63	57	-	38	6	62	59	35	M8 x 1	73	41,7	25	166
	22	34	9													
	28	42	12													
50	22	34	17	75	60	-	38	9	67	74	46	M12 x 1,25	74	52,3	25	176
	28	42	5													
	36	50	9													
63	28	42	27	90	60	-	38	5	71	91	46	M12 x 1,25	80	64,3	32	185
	36	50	9													
	45	60	12													
80	36	50	26	115	69	-	44	5	77	117	59	M16 x 1,5	93	82,7	31	212
	45	60	9													
	56	72	9													
100	45	60	30	130	73	-	44	5	82	137	59	M16 x 1,5	101	96,9	35	225
	56	72	5													
	70	88	9													
125	56	72	27	165	80	-	57	9	86	178	81	M22 x 1,5	117	125,9	35	260
	70	88	26													
	90	108	26													
160	70	88	26	205	88	-	57	7	86	219	92	M27 x 2	130	154,9	32	279
	90	108	6													
	110	133	6													
200	90	108	26	245	107	-	76	6	98	269	115	M30 x 2	165	190,2	32	336
	110	133	6													
	140	163	6													

TV23 Both Ends Extended Tie Rod Mounts (ISO MX1)

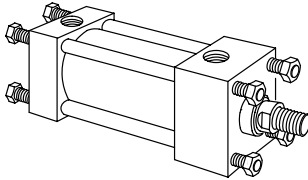

These mounts are for straight line force transfer applications. Both ends

extended tie rod mounts are suited for tension and compression applications or applications where additional hardware is to be attached to cylinders.

The mounting surface should be flat and the frame on which the cylinder is mounted must be sufficiently rigid to resist bending moments.

Once fitted into the application framework, the nuts which are provided should be torqued to the values listed in the table on page 19.

NOTE

For strokes in excess of 600mm, see "Stop tube selection" on page NO TAG.

The force on the rod should be perpendicular to the mounting surface and coincide with the centerline of the piston rod. For eccentric loads, the larger of the two available rods in each bore size is recommended. Stop tubes should also be considered.

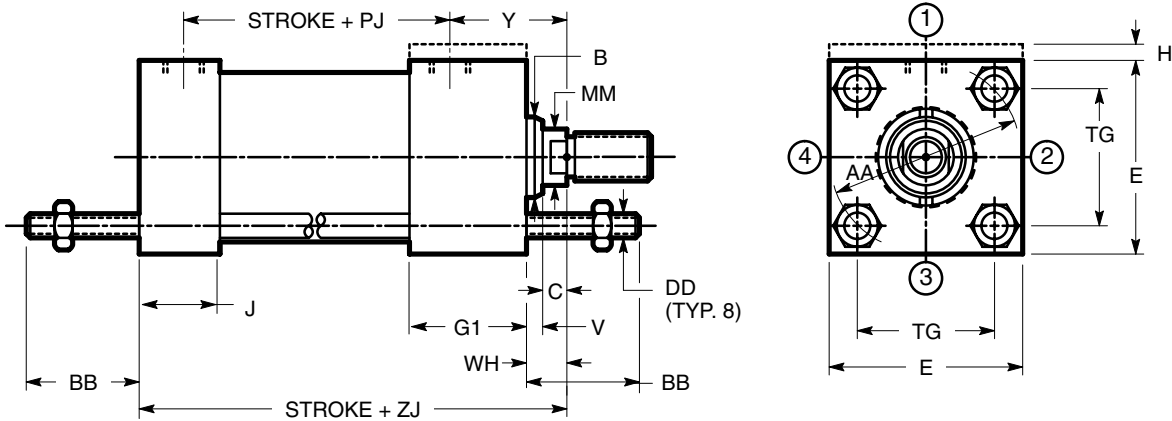

Bore	Rod MM	(f9) B	C	E	G1	H	J	V	Y	AA	BB	DD	PJ+	TG	WH	ZJ+
25	12 18	24 30	10 10	40 40	50 50	5 5	25 25	6 6	50 50	40 40	19 19	M5 x 0,8 M5 x 0,8	53 53	28,3 28,3	15 15	114 114
32	14 22	26 34	15 17	45 45	50 50	5 5	27 27	10 9	60 60	47 47	24 24	M6 x 1 M6 x 1	56 56	33,2 33,2	25 25	128 128
40	18 22 28	30 34 42	20 17 14	63	57	- - -	38	6 9 12	62	59	35	M8 x 1	73	41,7	25	153
50	22 28 36	34 42 50	17 20 17	75	60	- - -	38	9 5 9	67	74	46	M12 x 1,25	74	52,3	25	159
63	28 36 45	42 50 60	27 24 20	90	60	- - -	38	5 9 12	71	91	46	M12 x 1,25	80	64,3	32	168
80	36 45 56	50 60 72	26 23 23	115	69	- - -	44	5 9 9	77	117	59	M16 x 1,5	93	82,7	31	190
100	45 56 70	60 72 88	30 30 26	130	73	- - -	44	5 5 9	82	137	59	M16 x 1,5	101	96,9	35	203
125	56 70 90	72 88 108	27 26 26	165	80	- - -	57	9	86	178	81	M22 x 1,5	117	125,9	35	232
160	70 90 110	88 108 133	26	205	88	- - -	57	7 6 6	86	219	92	M27 x 2	130	154,9	32	245
200	90 110 140	108 133 163	26	245	107	- - -	76	6	98	269	115	M30 x 2	165	190,2	32	299

TV25 Double Rod End, Side Lug Mounts (ISO MX1)

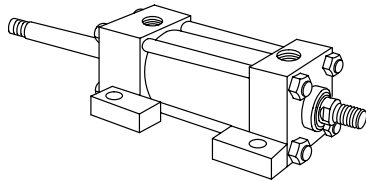

Double rod cylinders are specified when equal displacement is desired on both sides of the piston, or when the application is such that another function can be performed simultaneously with a second rod.

The single rod mount application data is also applicable to double rod cylinders.

NOTE

Limit operating pressure to 100 bar for minimum deflection.

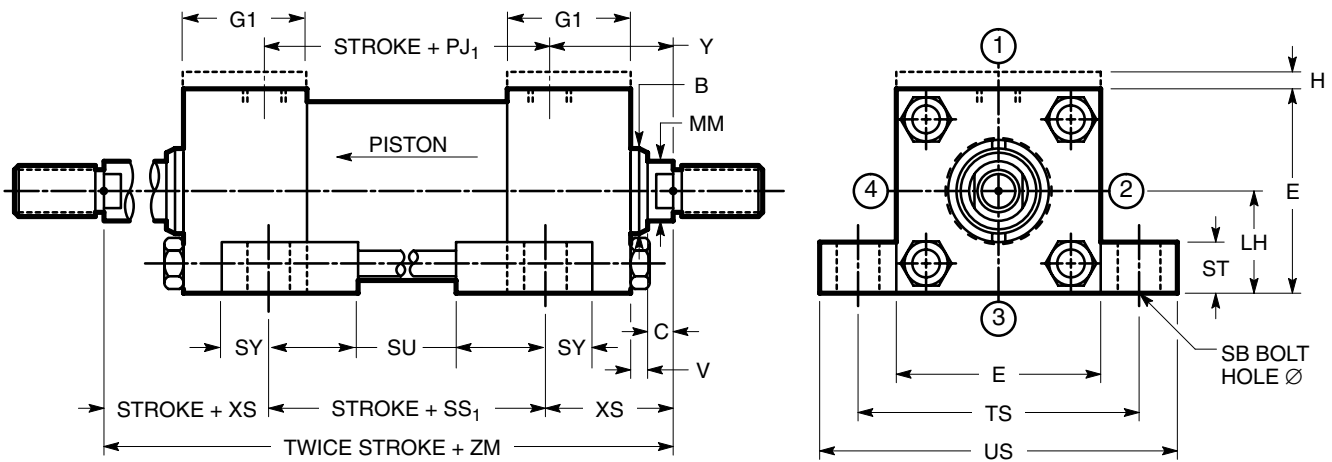

Bore	Rod MM	(f9) B	C	E	G1	H	V	Y	(h10) LH	PJ1+	SB	SS1+	ST	SU	SY	TS	US	XS	ZM++
25	12 18	24 30	10 10	40 40	50 50	5 5	6 6	50 50	19 19	51 51	6,6 6,6	85 85	9 9	19 19	8 8	54 54	72 72	33 33	151 151
32	14 22	26 34	15 17	45 45	50 50	5 5	10 9	60 60	22 22	56 56	9 9	86 86	13 13	23 23	10 10	63 63	84 84	45 45	176 176
40	18 22 28	30 34 42	20 17 14	63	57	- - -	6 9 12	62	31	69	11	103	13	23	10	83	103	45	193
50	22 28 36	34 42 50	17 20 17	75	60	- - -	9 5 9	67	37	72	14	98	19	33	12	102	127	54	206
63	28 36 45	42 50 60	27 24 20	90	60	- - -	5 9 12	71	44	81	18	93	26	40	17	124	161	65	223
80	36 45 56	50 60 72	26 23 23	115	69	- - -	5 9 9	77	57	92	18	110	26	40	17	149	186	68	246
100	45 56 70	60 72 88	30 30 26	130	73	- - -	5 5 9	82	63	103	26	109	32	51	22	172	216	79	268
125	56 70 90	72 88 108	27 26 26	165	80	- - -	9	86	82	114	26	128	32	51	22	210	254	79	286
160	70 90 110	88 108 133	26	205	88	- - -	7 6 6	86	101	137	33	137	38	63	29	260	318	86	309
200	90 110 140	108 133 163	26	245	107	- - -	6	98	122	160	39	172	44	73	35	311	381	92	356

+ Plus Stroke
++ Plus 2x Stroke

TV47 Cap Fixed Eye Mount (ISO MP3)

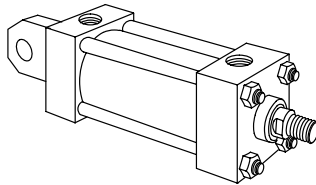

These mounts are for applications in which the machine member travels in a curved path within one plane.

These mounts can be used both in compression (push) and tension (pull). Care must be exercised to prevent rod buckling in compression applications with long strokes. See page 41 for stroke limitations.

NOTE

For strokes in excess of 500mm, see "Stop tube selection" on page NO TAG.

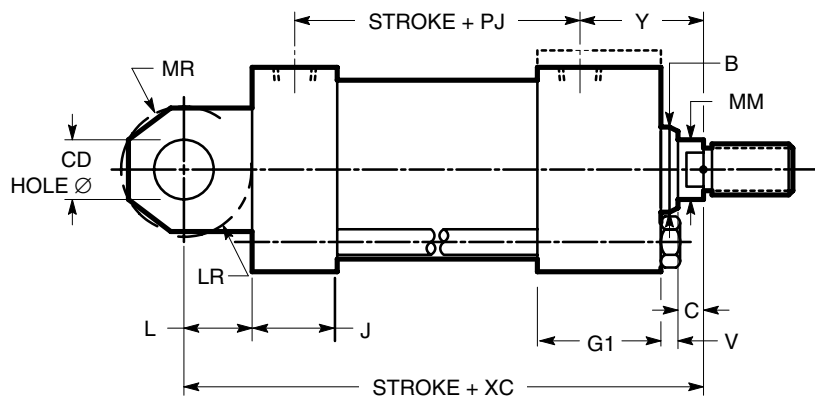
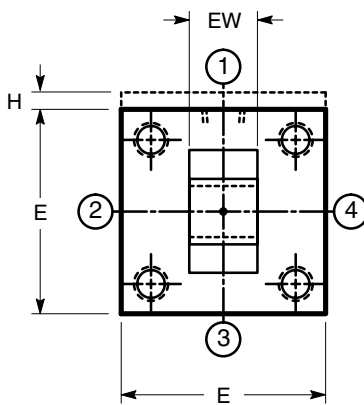

Bore	Rod MM	(f9) B	C	E	G1	H	J	L	V	Y	(h9) CD	EW	Min LR	Max MR	PJ+	XC+
25	12	24	10	40	50	5	25	13	6	50	10	12	12	12	53	127
	18	30	10	40	50	5	25	13	6	50	10	12	12	12	53	127
32	14	26	15	45	50	5	27	19	10	60	12	16	17	17	56	147
	22	34	17	45	50	5	27	19	9	60	12	16	17	17	56	147
40	18	30	20	63	57	-	38	19	6	62	14	20	17	17	73	172
	22	34	17						9							
	28	42	14						12							
50	22	34	17	75	60	-	38	32	9	67	20	30	29	29	74	191
	28	42	20						5							
	36	50	17						9							
63	28	42	27	90	60	-	38	32	5	71	20	30	29	29	80	200
	36	50	24						9							
	45	60	20						12							
80	36	50	26	115	69	-	44	39	5	77	28	40	34	34	93	229
	45	60	23						9							
	56	72	23						9							
100	45	60	30	130	73	-	44	54	5	82	36	50	50	50	101	257
	56	72	30						5							
	70	88	26						9							
125	56	72	27	165	80	-	57	57	9	86	45	60	53	53	117	289
	70	88	26						9							
	90	108	26						9							
160	70	88	26	205	88	-	57	63	7	86	56	70	59	59	130	308
	90	108							6							
	110	133							6							
200	90	108	26	245	107	-	76	82	6	98	70	80	78	78	165	381
	110	133							6							
	140	163							6							

Accessories

All rod accessories must be torqued against the rod shoulder.

Mounting brackets, rod clevises, and rod eyes for all TV cylinders are available from Vickers. These accessories are detailed below showing part numbers and all pertinent dimensional data.

When ordering, please specify the part name and part number.

Plain Swivel Pin (Includes two retaining rings)

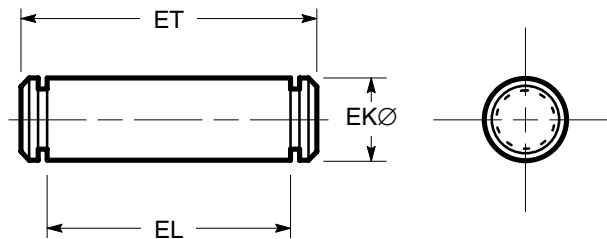

Part Number	EK	Min. EL	Max. ET	Maximum Load		Weight (kg)
				(kN)	(lbs)	
TV83010A-10	10 ^{-0,013/-0,035}	29	37,6	8	1800	0,023
TV83012A-10	12 ^{-0,016/-0,043}	37	45,6	12,5	2800	0,040
TV83016A-10	14 ^{-0,016/-0,043}	45	53,4	20	4500	0,061
TV83025A-10	20 ^{-0,020/-0,053}	66	75,2	50	11250	0,182
TV83030A-10	28 ^{-0,020/-0,053}	87	96,9	80	18000	0,407
TV83040A-10	36 ^{-0,025/-0,064}	107	120,5	125	28100	0,930
TV83050A-10	45 ^{-0,025/-0,064}	129	144,0	200	45000	1,635
TV83060A-10	56 ^{-0,030/-0,076}	149	164,6	320	72000	3,100
TV83080A-10	70 ^{-0,030/-0,076}	169	187,4	500	112400	5,390

Plain Rod Eye

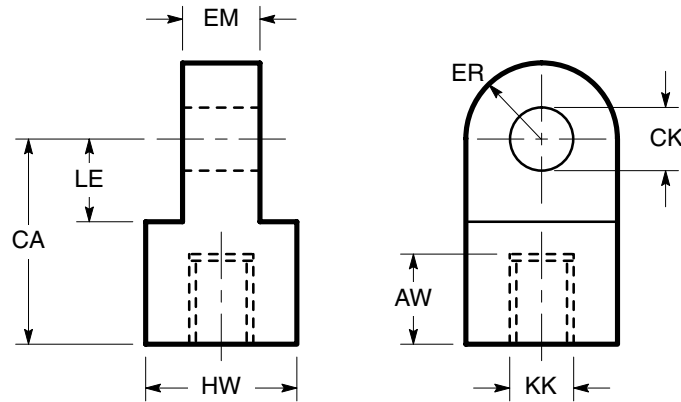

Part Number	Bore Ø	Min. AW	CA (js13)	CK (H9)	+0,00 EM (h13)	Max. ER
TV60010A	25	14	32 ±0,20	10 +0,036/-0,000	12 -0,27	12
TV60012A	32	16	36 ±0,20	12 +0,043/-0,000	16 -0,27	17
TV60016A	40	18	38 ±0,20	14 +0,043/-0,000	20 -0,33	17
TV60020A	50	22	54 ±0,23	20 +0,052/-0,000	30 -0,33	29
TV60025A	63	28	60 ±0,23	20 +0,052/-0,000	30 -0,33	29
TV60030A	80	36	75 ±0,23	28 +0,052/-0,000	40 -0,39	34
TV60040A	100	45	99 ±0,27	36 +0,062/-0,000	50 -0,39	50
TV60050A	125	56	113 ±0,27	45 +0,062/-0,000	60 -0,46	53
TV60060A	160	63	126 ±0,32	56 +0,074/-0,000	70 -0,46	59
TV60080A	200	85	168 ±0,32	70 +0,074/-0,000	80 -0,46	78

Part Number	Bore Ø	HW	KK*	Min. LE	Nominal Force	
					(kN)	(lbs)
TV60010A	25	18	M10 x 1,25	13	8	1800
TV60012A	32	22	M12 x 1,25	19	12,5	2800
TV60016A	40	20	M14 x 1,5	19	20	4500
TV60020A	50	30	M16 x 1,5	32	32	7200
TV60025A	63	33	M20 x 1,5	32	50	11250
TV60030A	80	40	M27 x 2	39	80	18000
TV60040A	100	50	M33 x 2	54	125	26100
TV60050A	125	65	M42 x 2	57	200	45000
TV60060A	160	90	M48 x 2	63	320	72000
TV60080A	200	110	M64 x 3	83	500	112400

* Proper rod end type must be selected.

Accessories

Spherical Bearing Clevis Bracket (per DIN 24556 / ISO 8133)

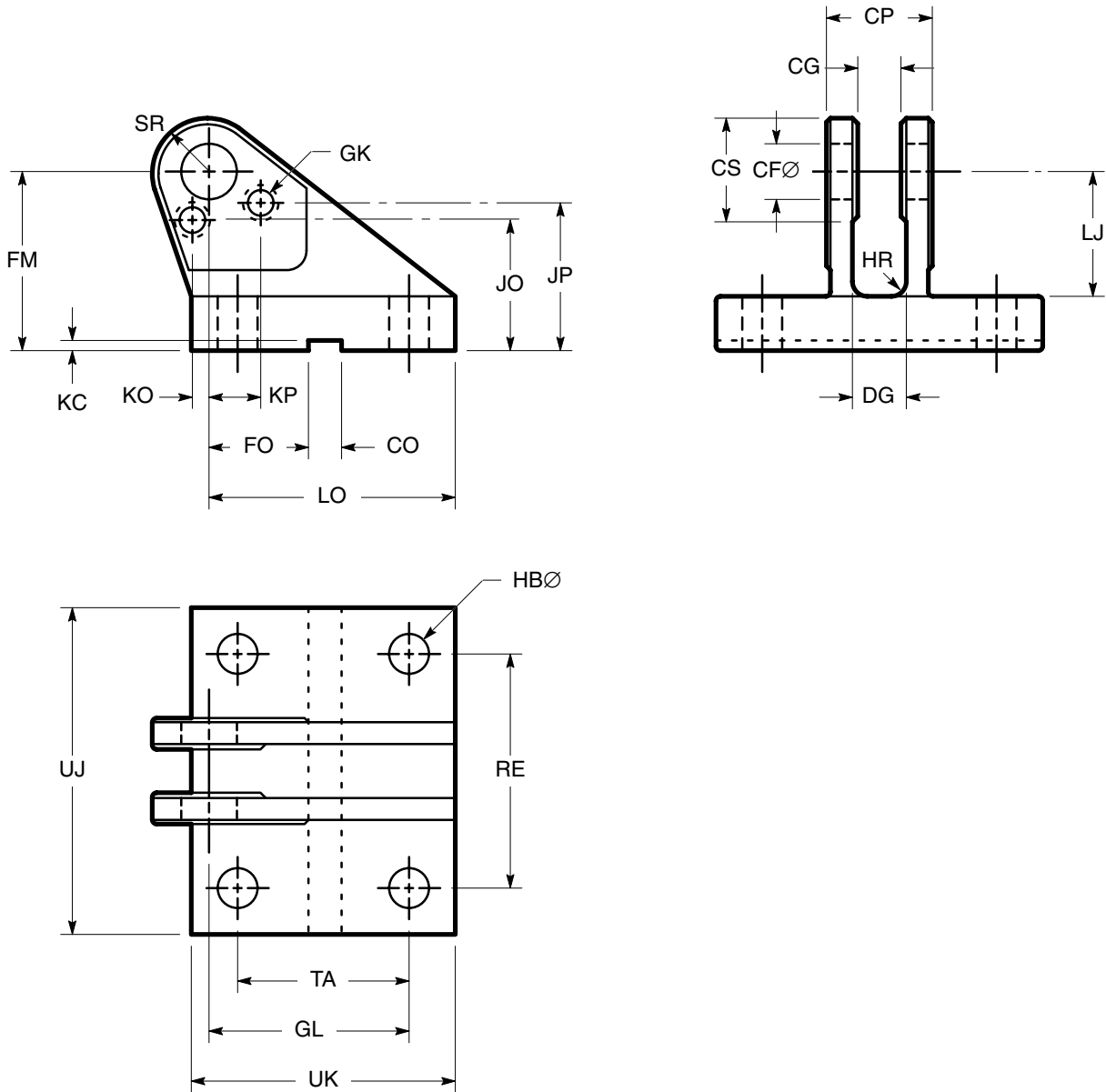

Part Number	CF (K7)	+0,3/+0,1 CG	+0,00 CO (N9)	CP (h14)	Max. CS	+2/-0 DG	FM (js11)	FO (js14)
TV61012B	12 +0,006/-0,012	10	10 -0,036	30 +0,00/-0,62	16	12	40 ±0,08	16 ±0,215
TV61016B	16 +0,006/-0,012	14	16 -0,043	40 +0,00/-0,62	22	16	50 ±0,10	18 ±0,26
TV61020B	20 +0,006/-0,015	16	16 -0,043	50 +0,00/-0,74	25	19	55 ±0,10	20 ±0,26
TV61025B	25 +0,006/-0,015	20	25 -0,052	60 +0,00/-0,74	30	24	65 ±0,10	22 ±0,26
TV61030B	30 +0,006/-0,015	22	25 -0,052	70 +0,00/-0,74	35	26	85 ±0,11	24 ±0,26
TV61040B	40 +0,007/-0,018	28	36 -0,062	80 +0,00/-0,87	47	32	100 ±0,11	24 ±0,26
TV61050B	50 +0,007/-0,018	35	36 -0,062	100 +0,00/-0,87	58	41	125 ±0,13	35 ±0,31
TV61060B	60 +0,009/-0,021	44	50 -0,062	120 +0,00/-1,00	68	50	150 ±0,13	35 ±0,31
TV61080B	80 +0,009/-0,021	55	50 -0,062	160 +0,00/-1,00	90	65	190 ±0,15	35 ±0,31
TV61100B	100 +0,010/-0,025	70	63 -0,074	200 +0,00/-1,15	111	80	210 ±0,15	35 ±0,31

Part Number	GK	GL (js13)	HB	HR	±0,2 JO	±0,2 JP	+0,30/-0,00 KC	±0,2 KO	±0,2 KP	LJ
TV61012B	M6	46 ±0,20	9	3	29,1	33,2	3,3	3,9	11,6	29
TV61016B	M6	61 ±0,23	11	3	36,7	42,2	4,3	5,2	18,9	38
TV61020B	M6	64 ±0,23	14	3	38,3	44,7	4,3	8,5	15,6	40
TV61025B	M6	78 ±0,23	16	4	48,5	48,5	5,4	11	14	49
TV61030B	M6	97 ±0,27	18	4	66	66	5,4	15	15	63
TV61040B	M8	123 ±0,32	22	4	77	77	8,4	21	21	73
TV61050B	M8	155 ±0,32	30	6	95,5	95,5	8,4	22,5	22,5	92
TV61060B	M10	187 ±0,36	39	6	116,5	116,5	11,4	27,5	27,5	110
TV61080B	M10	255 ±0,41	45	6	146	146	11,4	30	30	142
TV61100B	M10	285 ±0,41	48	6	154	154	12,4	45	45	152

Part Number	LO	RE (js13)	Max. SR	TA (js13)	UJ	UK	Max. Load (kN)	(lbs)	Weight (kg)	(lbs)
TV61012B	56	55 ±0,23	12	40 ±0,20	75	60	8	1800	0,52	1,15
TV61016B	74	70 ±0,23	16	55 ±0,23	95	80	12,5	2800	1,05	2,31
TV61020B	80	85 ±0,27	20	58 ±0,23	120	90	20	4500	1,72	3,79
TV61025B	98	100 ±0,27	25	70 ±0,23	140	110	32	7200	2,72	6,00
TV61030B	120	115 ±0,27	30	90 ±0,27	160	135	50	11250	5,15	11,35
TV61040B	148	135 ±0,32	40	120 ±0,32	190	170	80	18000	9,30	20,50
TV61050B	190	170 ±0,32	50	145 ±0,32	240	215	125	26100	18,3	40,3
TV61060B	225	200 ±0,36	60	185 ±0,36	270	260	200	45000	35,0	77,2
TV61080B	295	240 ±0,36	80	260 ±0,41	320	340	320	72000	63,0	138,9
TV61100B	335	300 ±0,41	100	300 ±0,41	400	400	500	112400	109,0	240,3

Accessories

Swivel Pin for Spherical Bearing with Retaining Rings

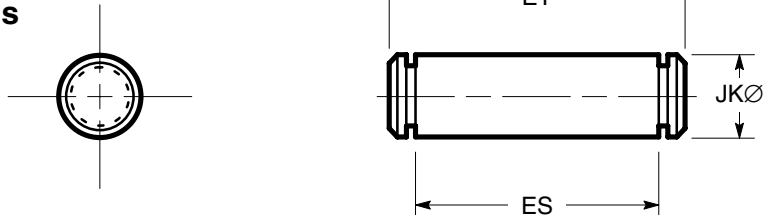

Part Number	JK		Max. ET	Min. ES	Max. Load		Weight (kg)
					(kN)	(lbs)	
TV83012C-10	12	+0,000/-0,011	39,6	31	8	1800	0,035
TV83016C-10	16	+0,000/-0,011	49,6	41	12,5	2800	0,075
TV83020C-10	20	+0,000/-0,013	60,2	51	20	4500	0,145
TV83025C-10	25	+0,000/-0,013	70,2	61	32	7200	0,260
TV83030C-10	30	+0,000/-0,013	80,8	71	50	11250	0,380
TV83040C-10	40	+0,000/-0,016	94,5	81	80	18000	0,895
TV83050C-10	50	+0,000/-0,016	116,5	101	125	26100	1,630
TV83060C-10	60	+0,000/-0,019	136,6	121	200	45000	2,950
TV83080C-10	80	+0,000/-0,019	179,2	161	320	72000	6,730
TV83100C-10	100	+0,000/-0,022	220,4	201	500	112400	13,500

Swivel Pin for Spherical Bearing with Locking Plate

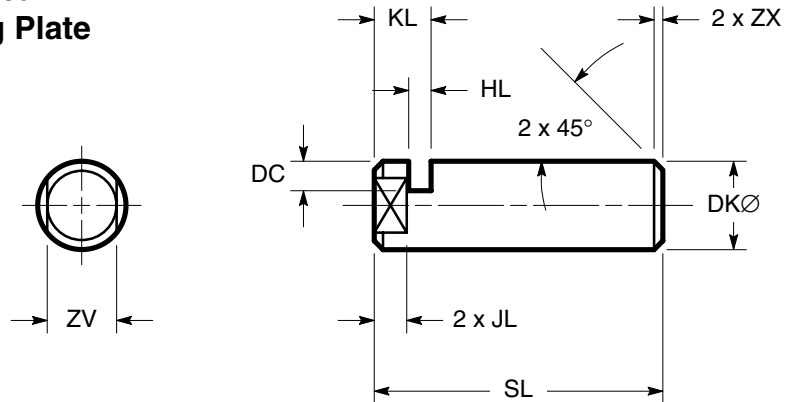

Part Number	+0,00 DK (h6)	DC	+0,2/-0,0 HL	JL	KL	SL	ZV	ZX	Max. Load		Weight (kg)
									(kN)	(lbs)	
TV83012B	12 -0,011	4	3,3	4,5	8	40	10	1	8	1800	0,035
TV83016B	16 -0,011	4	3,3	5,5	8	50	13	1	12,5	2800	0,075
TV83020B	20 -0,013	5	4,5	5,5	10	62	17	1,5	20	4500	0,150
TV83025B	25 -0,013	5	4,5	5,5	10	72	22	1,5	32	7200	0,270
TV83030B	30 -0,013	6	5,5	7,5	13	85	24	2	50	11250	0,410
TV83040B	40 -0,016	7	6,5	9,5	16	100	32	2	80	18000	0,950
TV83050B	50 -0,019	8	9,0	10,0	19	122	41	2	125	26100	1,710
TV83060B	60 -0,019	9	9,0	11,0	20	145	50	2	200	45000	3,130
TV83080B	80 -0,019	11	11,0	15,0	26	190	70	3	320	72000	7,140
TV83100B	100 -0,021	14	13,0	15,0	30	235	90	3	500	112400	14,400

Locking Plate for Swivel Pin

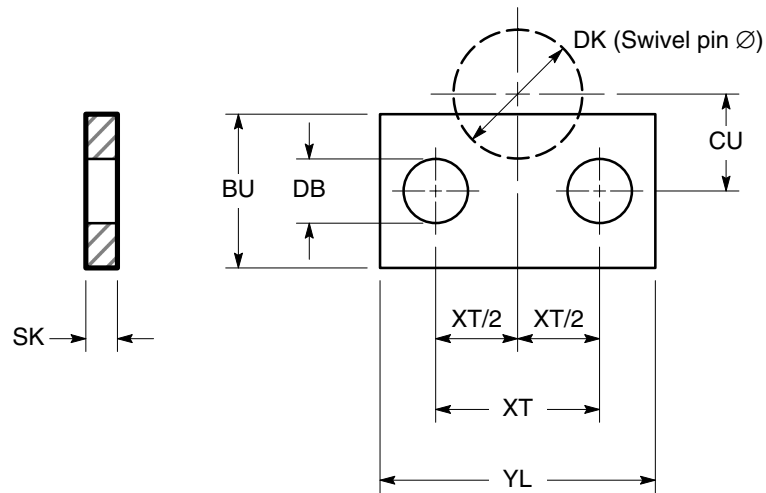

Part Number	DK	BU	DB	SK	YL	$\pm 0,2$ XT	Ref. CU	(2 included) Screw	Weight (kg)
7959-012	12	15	6,4	3	27	16	9,5	M6 x 12	0,015
7959-016	16	15	6,4	3	40	25	11,5	M6 x 12	0,020
7959-020	20	18	6,4	4	40	25	14,5	M6 x 15	0,032
7959-025	25	18	6,4	4	40	25	16,5	M6 x 15	0,032
7959-030	30	20	6,4	5	45	30	19,0	M6 x 15	0,050
7959-040	40	20	8,4	6	62	42	23,0	M8 x 20	0,078
7959-050	50	25	8,4	8	65	45	29,5	M8 x 20	0,090
7959-060	60	25	10,5	8	80	55	33,5	M10 x 25	0,170
7959-080	80	30	10,5	10	90	60	44,0	M10 x 25	0,250
7959-100	100	40	10,5	12	120	90	56,0	M10 x 25	0,490

Common Options Section

Rod End Types

In addition to selecting the correct bore, you must specify the appropriate rod size and rod end configuration for your application.

Five different rod end configurations are available. If a custom design is

required, contact your local Vickers sales engineer, and define your requirements.

The table on page NO TAG gives maximum allowable push strokes at various operating pressures for

available rod diameters of Series TV cylinders. Rod ends on rigid mount cylinders should be supported. Longer strokes are allowable for **pull only** applications. Contact your local Vickers sales engineer for application assistance if necessary.

0		N	
1		7	
6		For rod sizes 90, 110, and 140	

Dimensions in millimetres

Rod

MM	D	DC	Metric Thread							
			CC	AI	AX	KF	AF	KK	A	NA
12	10	—	M10 x 1,25	14	22	M8 x 1	12	M8 x 1	12	11
14	12	—	M12 x 1,25	16	24	M10 x 1,25	14	M10 x 1,25	14	13
18	15	—	M14 x 1,5	18	28	M12 x 1,25	16	M10 x 1,25	14	16,5
22	18	—	M16 x 1,5	22	32	M16 x 1,5	22	M12 x 1,25	16	20,5
28	22	—	M20 x 1,5	28	40	M20 x 1,5	28	M14 x 1,5	18	26
36	30	—	M27 x 2	36	54	M27 x 2	36	M16 x 1,5	22	34
45	38	—	M33 x 2	45	66	M33 x 2	45	M20 x 1,5	28	43
56	48	—	M42 x 2	56	84	M42 x 2	56	M27 x 2	36	53
70	62	—	M48 x 2	63	96	M48 x 2	63	M33 x 2	45	67
90	—	8	M64 x 3	85	128	M64 x 3	85	M42 x 2	56	87
110	—	10	M80 x 3	95	140	M80 x 3	95	M48 x 2	63	106
140	—	12	M100 x 3	112	168	M100 x 3	112	M64 x 3	85	136

See pages 9 through 23 for C dimensions.

Port Type and Size

Available Ports

Series TV cylinders are available with SAE straight thread O-ring ports and the alternate ports listed below.

The table below lists the port types and sizes available for each bore diameter. The table on page NO TAG lists the maximum piston velocities obtainable with each bore diameter and port type combination.

Some mounting styles have location restrictions. Where a port or port boss interferes with cylinder mounting, mounting takes precedence. See page 5 for a table of port location availability.

Code 3, 5 and A



Code 4 and B

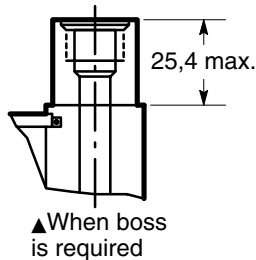

Code 6

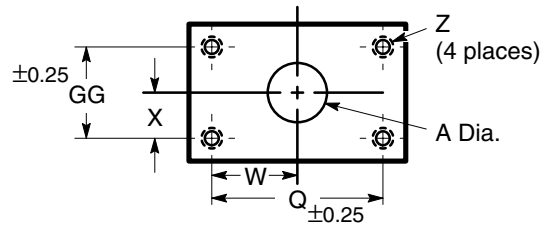

Dimensions in mm

Flange Size	A	Q	W	X	Z	GG
19	19,1	47,63	23,88	11,18	M10 x 1,5	22,23
25	25,4	52,37	26,16	13,21	M10 x 1,5	26,19
32	31,6	58,72	29,46	14,99	M12 x 1,75	30,18
38	38,1	69,85	35,05	17,78	M14 x 2	35,71

Code 7 and 9

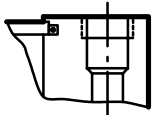

Code 8 and 0

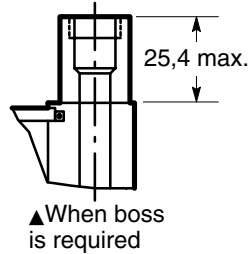

Bore Ø (mm)	Port Code									
	3	4	5 ^A	6	7 ^D	8	9	0	A	B
	SAE J1926 UN Thread O-ring / Thread Size			SAE 518 Code 61 Flange	ISO 228-1 BSPP		DIN 3852 Form X Metric		ISO 6149	
25	9/16-18 (-6)	3/4-16 (-8)▲	–	–	G ¹ / ₄	G ³ / ₈ ▲	M14 x 1,5	M22 x 1,5▲	M14 x 1,5	M22 x 1,5▲
32	9/16-18 (-6)	3/4-16 (-8)▲	–	–	G ¹ / ₄	G ³ / ₈ ▲	M14 x 1,5	M22 x 1,5▲	M14 x 1,5	M22 x 1,5▲
40	9/16-18 (-6)	7/8-14 (-10)	3/4-16 (-8)	–	G ³ / ₈	G ¹ / ₂	M22 x 1,5	M27 x 2▲	M22 x 1,5	M27 x 2▲
50	9/16-18 (-6)	7/8-14 (-10)	3/4-16 (-8)	–	G ¹ / ₂	G ³ / ₄ ▲	M22 x 1,5	M27 x 2▲	M22 x 1,5	M27 x 2▲
63	9/16-18 (-6)	7/8-14 (-10)	3/4-16 (-8)	–	G ¹ / ₂	G ³ / ₄ ▲	M22 x 1,5	M27 x 2▲	M22 x 1,5	M27 x 2▲
80	7/8-14 (-10)	1 ³ / ₁₆ -12 (-14)	1 ¹ / ₁₆ -12 (-12)	19	G ³ / ₄	G1▲	M27 x 2	M33 x 2▲	M27 x 2	M33 x 2▲
100	7/8-14 (-10)	1 ³ / ₁₆ -12 (-14)	1 ¹ / ₁₆ -12 (-12)	19	G ³ / ₄	G1▲	M27 x 2	M33 x 2▲	M27 x 2	M33 x 2▲
125	7/8-14 (-10)	1 ³ / ₁₆ -12 (-14)	1 ¹ / ₁₆ -12 (-12)	19	G1	G ¹ / ₄ ▲	M27 x 2	M33 x 2	M27 x 2	M33 x 2
160	1 ¹ / ₁₆ -12 (-12)	1 ⁵ / ₈ -12 (-20)▲	1 ⁵ / ₁₆ -12 (-16)	25	G1	G ¹ / ₄ ▲	M33 x 2	M42 x 2	M33 x 2	M42 x 2▲
200	1 ⁵ / ₁₆ -12 (-16)	1 ⁵ / ₈ -12 (-20)	1 ⁷ / ₈ -12 (-24)	38	G ¹ / ₄	G ¹ / ₂	M48 x 2	–	M48 x 2	–

^A - Size per ANSI B93.75M.

^D - Conforms to DIN 24554.

Port Location

Port locations are identified by viewing the cylinder from the head end (or from the mounting end of double rod cylinders). The location numbers are shown below.

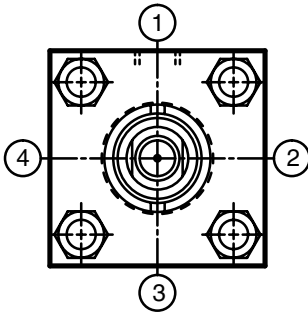

Certain port locations cannot be specified with some mounting styles. The table below indicates which of the head and cap port locations are available for each Series TV mounting style.

Mounting Style Code	Description	Head Locations				Cap Locations			
		1	2	3	4	1	2	3	4
01	Side lug	A	W	A	W	A	W	A	W
04	Keyed side lug	A	W	A	W	A	W	A	W
07	Head rectangular	A	A	A	A	A	A	A	A
09	Head rectangular	A	A	A	A	A	A	A	A
10	Clevis	A	A	A	A	A	A	A	A
11	Spherical bearing	A	A	A	A	A	A	A	A
14	Cap rectangular	A	A	A	A	A	A	A	A
15	Intermediate trunnion	A	A	A	A	A	A	A	A
16	Cap trunnion	A	A	A	A	A	N	A	N
17	Head trunnion	A	N	A	N	A	A	A	A
21	Cap extended tie rod	A	A	A	A	A	A	A	A
22	Head extended tie rod	A	A	A	A	A	A	A	A
23	Both ends extended tie rod	A	A	A	A	A	A	A	A
24	No mount	A	A	A	A	A	A	A	A
25	Double rod, side lug	A	W	A	W				
33	Double rod, head rectangular	A	A	A	A				
34	Double rod, intermediate trunnion	A	A	A	A				
35	Double rod, head trunnion	A	N	A	N				
39	Double rod, extended tie rod	A	A	A	A				
40	Double rod, both ends extended tie rod	A	A	A	A				
41	Double rod, no mount	A	A	A	A				
47	Cap fixed eye	A	A	A	A	A	A	A	A

A – Available

N – Not available

W – Port available without port boss only.

Proximity switch not available. (Port codes 3, 5, 7, and 9)

Sealing Systems

Three different sealing systems are available in Series TV cylinders.

Determine the correct seal code for your application, then enter it as item 8 in the model code.

Code	Fluid	Temperature (°C)	Max. Speed (m/s)	Application
N	Mineral oil, petroleum base Automotive transmission fluid	-35 to 80	0,7	Normal, typical industrial
L	Mineral oil Water glycol (HFC) Oil-in-water emulsions (HFA) Water-in-oil emulsions (HFB)	-35 to 120 10 to 70	5 1	Low friction servo Fire retardant fluids
T	Mineral oil Phosphate esters, petroleum oil blends Fyrquel 220, 550, 1000 Hought-O-Safe 1340 Pydraul 200, 230C, 280, 312C, 540C, A200	-25 to 200 0 to 200	5 5	High temperature Fire retardant fluids

Gland Drain Option

Gland drains are primarily used for long stroke cylinders (over 1 m) and when extended speed exceeds retract speed.

The gland drain is used to return any accumulated fluid, between the rod seal and wiper, to tank. This is used in servo applications, for ultra-low leakage requirements, or for remote visual monitoring of rod seal leakage for preventive maintenance purposes.

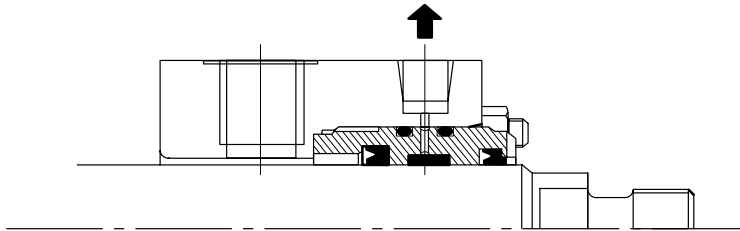

Air Bleed Option

Usually cylinders will bleed themselves of air when ports are vertical, on top. Bleed ports are often desirable to remove entrapped air, when the ports are on the bottom. High performance and high speed or heavy load applications are a few examples where air bleeds are desirable.

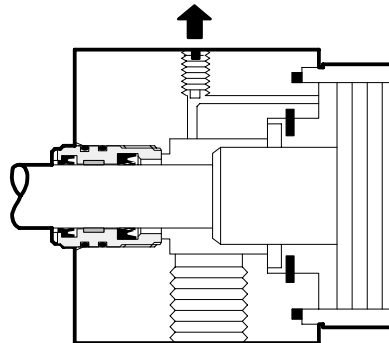

PS 200 Proximity Switches

PS 200 proximity switches for Series TV cylinders are inductive type switches with a sensing probe that “looks” at the cushion collar or button to provide full extend or full retract indication. Since the probe is inside the cylinder, harsh external environments don’t affect sensing. The 2-wire circuit will operate on AC or DC and works as reliably as a programmable controller. PS 200 switches meet UL requirements for 210

bar hydraulic cylinders. Vickers switch adaptor allows full 360° rotation.

Short Circuit Protection is a standard feature on the PS 200 Proximity Switch. SCP protects the switch from shorts in the load or line. Upon sensing a short condition, the switch assumes a non-conducting mode. The fault condition must be removed and power turned off in order to reset the switch.

This feature prevents unintended automatic restarts. The switch indicates when it is in SCP mode by flashing both LEDs.

Torque 1/4–20 mounting screws to 20 Nm (15 ft-lb).

O-rings required:

Size 115 – One per switch
Size 116 – One per spacer

Series PS 200 2-wire AC/DC Proximity Switches

Pressure	210 bar
Sensing range	2,0 mm ±10%
Operating temperature range	-20° to +70°C
Repeatability	0,025 mm
Switching differential	10%
Supply voltage	20–220 V AC/DC
On-State voltage drop	10V @ 5–500 mA
Load current man.	0,5 Amp
Inrush current	3 Amp
Quiescent current	1,7 mA max.
Indicating LED's (standard)	1 lit: Power on non-conducting 2 lit: Target present (both flashing = SCP mode)

Dimensions in millimetres

Bore Ø	Rod Ø	Max. D
25	12	N/A
	18	N/A
	Cap	N/A
32	14	N/A
	22	N/A
	Cap	N/A
40	18	94
	22	94
	28	94
	Cap	94
50	22	104
	28	97
	36	97
	Cap	97
	36	113
63	28	113
	36	113
	45	113
	Cap	113
80	36	115
	45	115
	56	121
	Cap	115
	45	132
100	56	121
	70	121
	Cap	121
	56	157
	70	157
125	90	157
	Cap	157
	70	157
	90	167
160	70	157
	90	167
	110	165
	Cap	157
200	90	189
	110	182
	140	182
	Cap	182

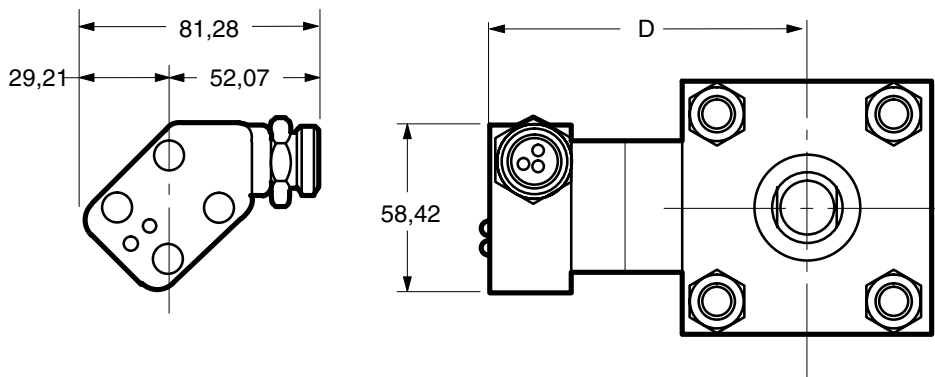

With the new Vickers switch adaptor, the proximity switch can rotate 360°. Use the chart on previous page for available proximity switch locations for the various mounting styles.

Application / Engineering Data

Stop Tube Selection

The following table lists the maximum stroke permissible without the use of a stop tube. Strokes are listed for rigid mounting styles as well as clevis and trunnion pivot mounts.

As the stroke length of a cylinder increases, the resultant bearing loads on the piston rod become greater. To keep these bearing loads from exceeding design limitations, and to obtain optimum life from a cylinder, stop tubes should be specified according to the following procedure:

To order a stop tube, enter XXX for model code item 8. Then specify the cylinder's working stroke and the required stop tube length. Specify 25 mm of stop tube for each 250 mm (or fraction thereof) of stroke in excess of the maximums listed in the table.

Bore Ø (mm)	Maximum Stroke (mm)		
	Pivot Mounts	Rigid mounts	
		Unsupported Rod	Supported Rod
25	500	600	1000
32	500	600	1000
40	600	750	1200
50	600	750	1200
63	750	965	1200
80	750	965	1200
100	750	965	1200
125	900	1000	1200
160	900	1000	1200
200	900	1000	1200

Stop Tube Designs

Three typical stop tube designs are illustrated below.

Design A

Used for cylinders not cushioned on the rod end.

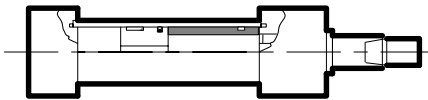

Design B

Used for cushioned hydraulic cylinders.

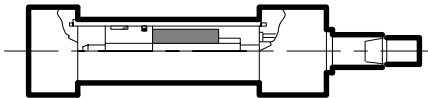

Design C

The best choice for a cylinder with an exceptionally long stop tube requirement. Note that the piston's effective bearing area is doubled, in addition to gaining the normal increased

minimum distance between bearing points.

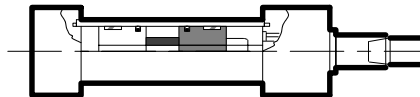

Tie Rod Spacers and Center Supports

A tie rod spacer or center support should be applied when the stroke length exceeds 20 times the bore diameter.

Tie rod spacer

Tie rod spacers and center supports are used to improve the structural rigidity of long stroke tie rod cylinders.

The spacers have through holes for the tie rods and are held in place on the cylinder barrel with a small tack weld or set screw.

The spacer keeps the tie rod in the proper position around the centerline of the cylinder and acts much like a truss in preventing excessive deflection in a long stroke cylinder that is not rigidly mounted (clevis mount, etc.).

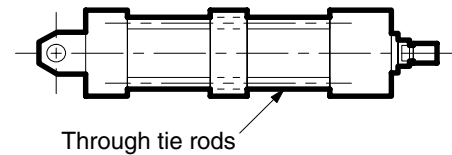

Tie rod center support

The center support has side mounting lugs similar to side lug mount heads and serves as an additional mounting location. The tie rods are threaded into the center support and it becomes a load-carrying component of the cylinder assembly.

The exact location of the tie rod center support is generally optional, which greatly increases the flexibility in mounting a long stroke cylinder.

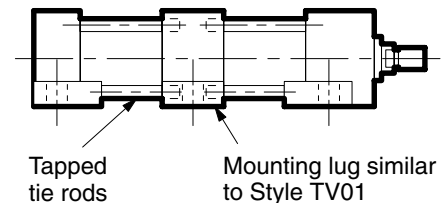

Tapped tie rods

Mounting lug similar to Style TV01

Bore & Rod Diameters

Cylinder Size Selection

To choose the proper size of cylinder for your application, first determine the maximum push and/or pull force required to do the job. Then use the table below to select the cylinder that will provide that force. Remember that force capabilities derived from charts

and formulas may be theoretically correct, but other factors must be considered. Be sure to allow for pressure drop between the pump outlet and the cylinder port. Also, some of a cylinder's force is used up overcoming seal friction and, to a lesser extent, the inertia of the piston itself. In Vickers cylinders, the amount of extra force needed to compensate for these factors has been limited to 5% or less of the

cylinder's theoretical power—without sacrificing sealing performance.

For maximum reliability and fatigue life of the piston rod, the largest rod offered in a given bore size should be specified. The smaller rods for a given bore are primarily intended for short stroke push loading or reduced pressure applications.

Bore ∅ (mm)	Rod ∅ (mm)	Work Area (cm ²)	Maximum Force (kN) At Working Pressure (bar)						
			30 (bar)	50 (bar)	70 (bar)	100 (bar)	140 (bar)	160 (bar)	210 (bar)
25	—	4,9	1,47	2,45	3,44	4,91	6,87	7,85	10,31
	12	3,8	1,13	1,89	2,64	3,78	5,29	6,04	7,93
	18	2,4	0,71	1,18	1,65	2,36	3,31	3,78	4,96
32	—	8,0	2,41	4,02	5,63	8,04	11,26	12,87	16,89
	14	6,5	1,95	3,25	4,55	6,50	9,10	10,40	13,66
	22	4,2	1,27	2,12	2,97	4,24	5,94	6,79	8,91
40	—	12,6	3,77	6,28	8,80	12,57	17,59	20,11	26,39
	18	10,0	3,01	5,01	7,02	10,02	14,03	16,03	21,05
	22	8,8	2,63	4,38	6,14	8,77	12,27	14,03	18,41
	28	6,4	1,92	3,20	4,49	6,41	8,97	10,25	13,46
50	—	19,6	5,89	9,82	13,74	19,63	27,49	31,42	41,23
	22	15,8	4,75	7,92	11,08	15,83	22,17	25,33	33,25
	28	13,5	4,04	6,74	9,44	13,48	18,87	21,57	28,31
	36	9,5	2,84	4,73	6,62	9,46	13,24	15,13	19,86
63	—	31,2	9,35	15,59	21,82	31,17	43,64	49,88	65,46
	28	25,0	7,50	12,51	17,51	25,01	35,02	40,02	52,53
	36	21,0	6,30	10,50	14,70	21,00	29,39	33,59	44,09
	45	15,3	4,58	7,63	10,69	15,27	21,38	24,43	32,06
80	—	50,3	15,08	25,13	35,19	50,27	70,37	80,42	105,56
	36	40,1	12,03	20,04	28,06	40,09	56,12	64,14	84,18
	45	34,4	10,31	17,18	24,06	34,37	48,11	54,99	72,17
	56	25,6	7,69	12,82	17,94	25,64	35,89	41,02	53,83
100	—	78,5	23,56	39,27	54,98	78,54	109,96	125,66	164,93
	45	62,6	18,79	31,32	43,84	62,64	87,69	100,22	131,53
	56	53,9	16,18	26,96	37,74	53,92	75,48	86,27	113,23
	70	40,1	12,02	20,03	28,04	40,06	56,08	64,09	84,12
125	—	122,7	36,82	61,36	85,90	122,72	171,81	196,35	257,71
	56	98,1	29,43	49,04	68,66	98,09	137,32	156,94	205,99
	70	84,2	25,27	42,12	58,97	84,24	117,94	134,79	176,91
	90	59,1	17,73	29,55	41,37	59,10	82,74	94,56	124,11
160	—	201,1	60,32	100,53	140,74	201,06	281,49	321,70	422,23
	70	162,6	48,77	81,29	113,80	162,58	227,61	260,12	341,41
	90	137,5	41,24	68,73	96,22	137,46	192,45	219,94	288,67
	110	106,0	31,81	53,01	74,22	106,03	148,44	169,65	222,66
200	—	314,2	94,25	157,08	219,91	314,16	439,82	502,65	659,73
	90	250,5	75,16	125,27	175,38	250,54	350,76	400,87	526,14
	110	219,2	65,75	109,58	153,41	219,15	306,82	350,65	460,22
	140	160,2	48,07	80,11	112,15	160,22	224,31	256,35	336,46

Maximum Allowable Push Strokes

In push applications, a cylinder acts as a loaded column. There are two basic ways to measure the column length.

Pivot mounts:

The length is measured from the pivot point to the end of the rod in the fully extended position.

Flange and other rigid mounts:

The exposed piston rod is considered to be the column length with a fixed end at the cylinder which allows longer strokes.

To use the table below, first go to the section for your mounting style. Then locate the column which is closest to, but not below, your application's operating pressure. The intersection of

operating pressure and bore/rod size represents the maximum allowable push stroke. This maximum stroke is based on column loading analysis only and does not consider side loading, stop tube requirements or other cylinder stroke limiters.

For pressures above 210 bar, consult your local Vickers representative.

BORE ROD Ø (mm) Ø (mm)		Maximum Stroke (mm) at Working Pressure (bar)																	
		Rigid Mounts (01, 04, 07, 09, 14, 21, 22, 23, 25, 33, 39, 40, and 47)						Cap Swivel Mounts (10, 11, and 16)					Trunnion Mounts (15, 17, 34, and 35)						
		30	50	70	100	160	210	30	50	70	100	160	210	30	50	70	100	160	210
25	12	758	566	460	361	243	175	337	252	205	161	108	78	404	302	246	193	130	94
	18	1754	1339	1114	910	684	569	780	595	495	405	304	253	936	714	595	486	365	304
32	14	797	591	475	366	230	145	355	263	211	163	102	64	425	315	254	195	123	77
	22	2042	1556	1293	1054	787	651	908	692	575	469	350	289	1090	831	690	562	420	347
40	18	1058	786	635	491	317	211	471	350	282	219	141	94	565	419	339	262	169	112
	22	1612	1216	999	799	569	446	717	541	444	355	253	198	860	649	533	426	304	238
	28	2649	2020	1680	1370	1025	850	1178	898	747	609	456	378	1414	1078	896	731	547	454
50	22	1261	935	753	580	367	234	561	416	335	258	163	104	673	499	402	309	196	125
	28	2091	1579	1299	1041	745	588	930	702	578	463	331	261	1116	843	693	556	398	314
	36	3508	2677	2228	1820	1367	1138	1560	1191	991	810	608	506	1872	1429	1189	971	730	607
63	28	1623	1204	971	750	479	311	722	536	432	333	213	138	866	643	518	400	255	166
	36	2748	2077	1711	1374	989	785	1222	924	761	611	440	349	1466	1109	913	733	528	419
	45	4348	3318	2761	2254	1691	1407	1934	1475	1228	1003	752	626	2321	1771	1473	1203	903	751
80	36	2116	1572	1269	983	634	422	941	699	564	437	282	187	1129	839	677	525	338	225
	45	3377	2551	2099	1683	1206	953	1502	1134	934	748	536	424	1802	1361	1120	898	644	508
	56	5298	4040	3359	2740	2050	1701	2356	1797	1494	1219	912	756	2827	2156	1793	1462	1094	908
100	45	2645	1965	1587	1229	792	527	1176	874	706	546	352	234	1412	1049	847	656	423	281
	56	4183	3158	2599	2082	1490	1175	1860	1405	1156	926	663	523	2232	1686	1387	1111	795	627
	70	6623	5050	4199	3425	2563	2126	2945	2246	1867	1523	1140	945	3534	2695	2241	1828	1368	1134
125	56	3275	2432	1963	1518	976	644	1457	1082	873	675	434	286	1748	1298	1047	810	521	344
	70	5228	3948	3248	2603	1863	1469	2325	1756	1445	1158	828	653	2790	2107	1733	1389	994	784
	90	8769	6693	5571	4551	3418	2846	3900	2976	2477	2024	1520	1266	4680	3572	2973	2429	1824	1519
160	70	3986	2953	2376	1828	1151	724	1773	1313	1057	813	512	322	2127	1576	1268	975	614	386
	90	6754	5102	4199	3366	2412	1905	3004	2269	1867	1497	1073	847	3605	2723	2241	1796	1287	1017
	110	10212	7782	6467	5269	3933	3254	4542	3461	2876	2343	1749	1447	5450	4153	3451	2812	2099	1736
200	90	5290	3930	3173	2457	1584	1054	2353	1748	1411	1093	705	469	2823	2097	1693	1311	846	562
	110	8058	6079	4995	3995	2844	2228	3584	2703	2222	1777	1265	991	4300	3244	2666	2132	1518	1189
	140	13245	10100	8398	6850	5126	4252	5890	4491	3735	3046	2279	1891	7068	5390	4482	3656	2735	2269

Port Selection

Use this table to determine which bore diameter, rod diameter, and port combination will provide the piston velocity required for your application.

Bore Ø (mm)	Rod Ø (mm)	Fluid Req. per 10 mm of of Stroke (l)	Port Code 3		Port Codes 4 and 0, B		Port Codes 5, 6, and 9, A		Port Code 7		Port Code 8	
			Flow (l/min)	Piston Velocity (m/s)	Flow (l/min)	Piston Velocity (m/s)	Flow (l/min)	Piston Velocity (m/s)	Flow (l/min)	Piston Velocity (m/s)	Flow (l/min)	Piston Velocity (m/s)
25	Cap	0,0049	13,4	0,46	23,2	0,79	13,4	0,46	4,5	0,15	13,4	0,46
	12	0,0038	13,4	0,59	23,2	1,02	13,4	0,59	4,5	0,20	13,4	0,59
	18	0,0024	13,4	0,94	23,2	1,64	13,4	0,94	4,5	0,32	13,4	0,94
32	Cap	0,0080	13,4	0,28	23,2	0,48	13,4	0,28	4,5	0,09	13,4	0,28
	14	0,0065	13,4	0,34	23,2	0,60	13,4	0,34	4,5	0,12	13,4	0,34
	22	0,0042	13,4	0,53	23,2	0,91	13,4	0,53	4,5	0,18	13,4	0,53
40	Cap	0,0126	13,4	0,18	35,6	0,47	23,2	0,31	13,4	0,18	23,2	0,31
	18	0,0100	13,4	0,22	35,6	0,59	23,2	0,39	13,4	0,22	23,2	0,39
	22	0,0088	13,4	0,25	35,6	0,68	23,2	0,44	13,4	0,25	23,2	0,44
	28	0,0064	13,4	0,35	35,6	0,93	23,2	0,60	13,4	0,35	23,2	0,60
50	Cap	0,0196	13,4	0,11	35,6	0,30	23,2	0,20	23,2	0,20	56,4	0,48
	22	0,0158	13,4	0,14	35,6	0,38	23,2	0,24	23,2	0,24	56,4	0,59
	28	0,0135	13,4	0,17	35,6	0,44	23,2	0,29	23,2	0,29	56,4	0,70
	36	0,0095	13,4	0,24	35,6	0,63	23,2	0,41	23,2	0,41	56,4	0,99
63	Cap	0,0312	13,4	0,07	35,6	0,19	23,2	0,12	23,2	0,12	56,4	0,30
	28	0,0250	13,4	0,09	35,6	0,24	23,2	0,16	23,2	0,16	56,4	0,38
	36	0,0210	13,4	0,11	35,6	0,28	23,2	0,18	23,2	0,18	56,4	0,45
	45	0,0153	13,4	0,15	35,6	0,39	23,2	0,25	23,2	0,25	56,4	0,62
80	Cap	0,0503	35,6	0,12	78,6	0,26	56,4	0,19	56,4	0,19	108,3	0,36
	36	0,0401	35,6	0,15	78,6	0,33	56,4	0,23	56,4	0,23	108,3	0,45
	45	0,0344	35,6	0,17	78,6	0,38	56,4	0,27	56,4	0,27	108,3	0,53
	56	0,0256	35,6	0,23	78,6	0,51	56,4	0,37	56,4	0,37	108,3	0,70
100	Cap	0,0785	35,6	0,08	78,6	0,17	56,4	0,12	108,3	0,12	108,3	0,23
	45	0,0626	35,6	0,10	78,6	0,21	56,4	0,15	108,3	0,29	108,3	0,29
	56	0,0539	35,6	0,11	78,6	0,24	56,4	0,17	108,3	0,33	108,3	0,33
	70	0,0401	35,6	0,15	78,6	0,33	56,4	0,24	108,3	0,45	108,3	0,45
125	Cap	0,1227	35,6	0,05	78,6	0,11	108,3	0,15	108,3	0,15	176,6	0,24
	56	0,0981	35,6	0,06	78,6	0,13	108,3	0,18	108,3	0,18	176,6	0,30
	70	0,0842	35,6	0,07	78,6	0,16	108,3	0,21	108,3	0,21	176,6	0,35
	90	0,0591	35,6	0,10	78,6	0,22	108,3	0,30	108,3	0,30	176,6	0,50
160	Cap	0,2011	56,4	0,05	176,6	0,15	108,3	0,09	108,3	0,09	176,6	0,15
	70	0,1626	56,4	0,06	176,6	0,18	108,3	0,11	108,3	0,11	176,6	0,18
	90	0,1375	56,4	0,07	176,6	0,21	108,3	0,13	108,3	0,13	176,6	0,21
	110	0,1060	56,4	0,09	176,6	0,28	108,3	0,17	108,3	0,17	176,6	0,28
200	Cap	0,3142	108,3	0,06	176,6	0,09	261,7	0,14	176,6	0,09	261,7	0,14
	90	0,2505	108,3	0,07	176,6	0,12	261,7	0,17	176,6	0,12	261,7	0,17
	110	0,2192	108,3	0,08	176,6	0,13	261,7	0,20	176,6	0,13	261,7	0,27
	140	0,1602	108,3	0,11	176,6	0,18	261,7	0,27	176,6	0,18	261,7	0,27

Cushioning System

Vickers cylinders have standard features that are extra cost options or not available on other look-alike ISO/DIN cylinders. Series TV hydraulic cylinders are available with a patented floating ring cushion seal or alternate solid design with check valve that provide positive cushion sealing with minimum wear and maximum piston acceleration on the return stroke.

Advanced Cushions Provide Faster Cycle Times

Cylinder cushions are designed to decelerate the piston velocity near the end of each cylinder stroke to prevent excessive mechanical shock.

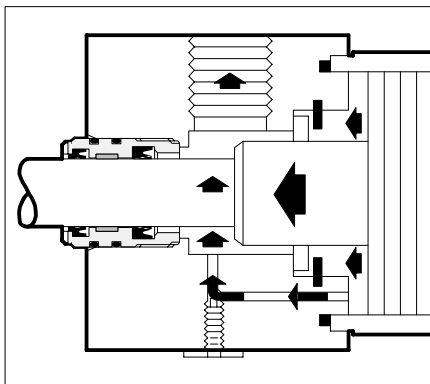

To accomplish this, the cushion collar contacts a floating sleeve or cylinder head which permits a very close seal contact without high loading. The sleeve seats against the head and provides a very effective seal to trap the fluid. Consistent performance and long life are provided.

Vickers advanced cushions permit higher cylinder speed, shorter cycle time, and more work per hour.

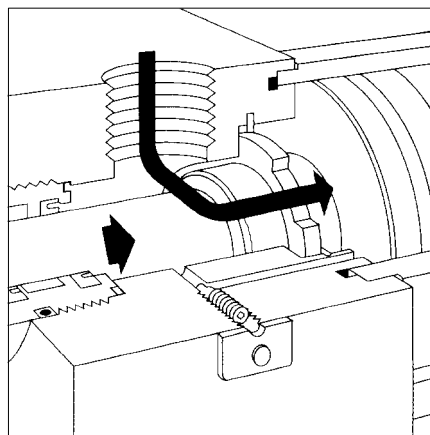

The sleeve design is also free to move in an axial direction and functions as a fluid check. When the fluid flow is reversed, the sleeve moves off its seat, and fluid flows around the slots in the outer sleeve's diameter permitting nearly full flow for quick acceleration.

Cushion Features

- Cushion design provides consistent long wearing seal between cushion collar and head.
- Floating design self-aligns to minimize wear.
- Check valve action of sleeve provides rapid acceleration out of the cushion.

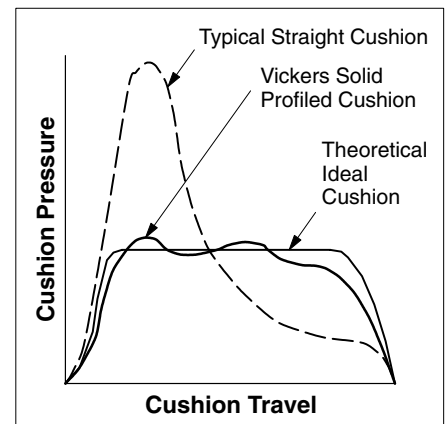

Cushions are recommended when piston speed exceeds 0,13 m/s. Any heavy loads attached to the piston rod should be absorbed by external means such as shock absorbers or springs.

Application Data

Cushioning System

Key Assumptions & Limitations

These assumptions provide parameters for determining maximum cushion performance. Actual performance may be different than determined by these methods, particularly if assumptions are not maintained.

Efficiency factors are applied to the energy calculations that attempt to reflect characteristics of the Vickers cushion design.

The following assumptions should be considered when calculating cushion capacity:

- Maximum cushion pressure is 310 bar (4500 psi).
- The upper limit of velocity is 0.5 m/s.
- If velocity is below 0,13 m/s, the cushions become ineffective on cylinders smaller than 80 mm bore.
- Friction force is assumed to be zero.
- The cylinder is used in a linear system (not for rotary applications).
- Fluid viscosity is equivalent to 25 centistoke.
- The driving pressure is equal to the maximum system pressure, usually the relief valve setting.
- Cushion adjustment screws are provided to tune cushion performance within limits.
- Cushion efficiency (C_{eff}) is 0.67 for velocities between 0,1 and 0,3 m/s., or 0,5 for velocities between 0,3 and 0,5 m/s.

Application 1



Application 2

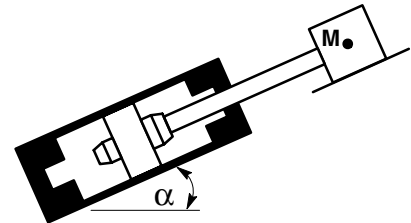

Application 3

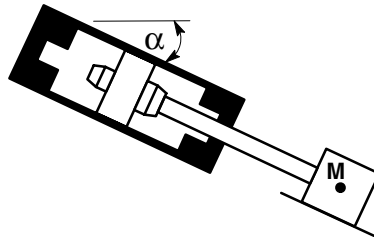

Application 1:

$$E = [0,5 M V^2] \text{ extend or retract}$$

Application 2:

$$E = (1/C_{eff}) \{ [0,5 M V^2] - [9,81 M (L_{hc}/1000 \sin(\alpha))] \} \text{ extend}$$

$$E = (1/C_{eff}) \{ [0,5 M V^2] + [9,81 M (L_{cc}/1000 \sin(\alpha))] \} \text{ retract}$$

Application 3:

$$E = (1/C_{eff}) \{ [0,5 M V^2] + [9,81 M (L_{hc}/1000 \sin(\alpha))] \} \text{ extend}$$

$$E = (1/C_{eff}) \{ [0,5 M V^2] - [9,81 M (L_{cc}/1000 \sin(\alpha))] \} \text{ retract}$$

Calculations for TV Cylinder

Units (US)

E	Energy	joule
M	Mass	kg
V	Velocity	m/s
P_d	Driving pressure	bar
L_H	Head cushion length	mm
L_C	Cap cushion length	mm
g	Gravity constant	9,81/1000

Example

TV cylinder in application 3 and extending:

Using a TV cylinder with a 100 mm bore, 45 mm rod is mounted at a 45° angle from horizontal with rod down. A 1300 kg mass is attached to the rod and system pressure is 100 bar. The cylinder is moving the mass at 0,3 m/s.

Using the calculation for application 3:

$$E = (1/C_{eff}) \{ [0,5 M V^2] + [9,81 M (L_{hc}/1000 \sin(\alpha))] \}$$

$$E = (1/0.67) \{ [0,5 * 1300 * 0,3^2] + [9,81 * 1300 * (33/1000) * \sin(45)] \}$$

$$E = 531 \text{ newton-m (joule)}$$

Pick the chart (see page 46) for TV cylinder, rod extending, and first rod. The curve is for the 100/45 bore/rod. Enter the vertical axis at 531 newton-m and the horizontal axis at 100 bar. The point of intersection is below the 100/45 curve so the cushion is acceptable. The maximum allowable pressure on the cap end is 160 bar which is greater than the specified system pressure of 100 bar.

Cushion Data

Bore Diameter (mm)	Rod Diameter (mm)	Model Code Designation Bore/Rod	Max. Cap Pressure (bar)	L _C Effective Cap End Cushion Length (mm)	L _H Effective Head End Cushion Length (mm)
25	12	BB	160	17	20
25	18	BE	112	17	20
32	14	2C	160	17	20
32	22	2G	136	17	20
40	18	CE	160	26	23
40	22	CG	158	26	25
40	28	CJ	124	26	30
50	22	DG	160	26	28
50	28	DJ	160	26	28
50	36	DL	91	26	30
63	28	EJ	160	26	21
63	36	EL	160	26	30
63	45	EN	115	26	30
80	36	GL	160	30	30
80	45	GN	160	30	30
80	56	GQ	118	30	35
100	45	HN	160	32	33
100	56	HQ	160	32	35
100	70	HS	131	32	35
125	56	KQ	160	40	40
125	70	KS	160	40	40
125	80	KU	119	40	35
160	70	LS	160	40	40
160	90	LU	160	40	38
160	110	LW	141	40	37
200	90	NU	160	55	40
200	110	NW	160	55	40
200	140	NZ	136	55	40

Energy Absorbing Potential Charts

**TV Cap Cushion - Rod Retracting
First Rod**

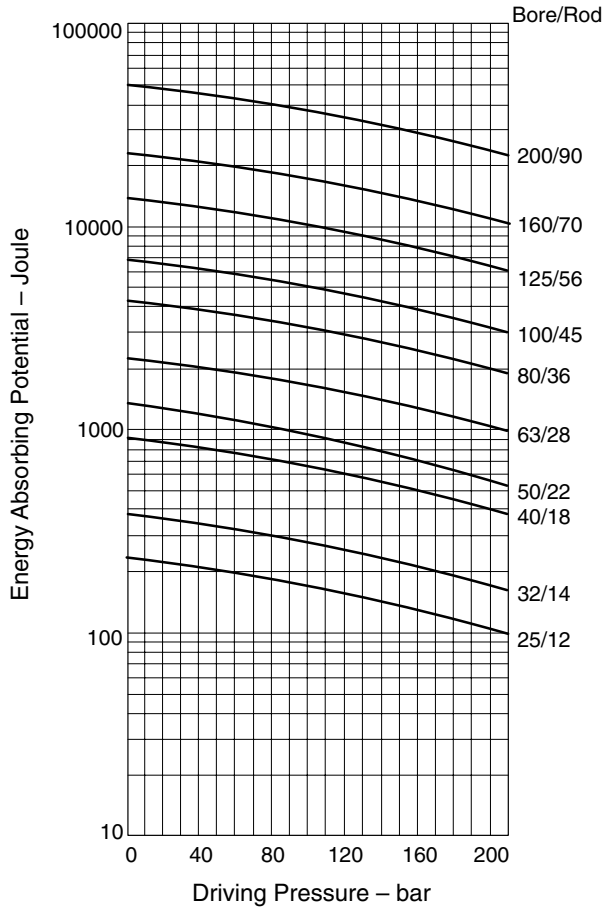

**TV Rod Cushion - Rod Extending
First Rod**

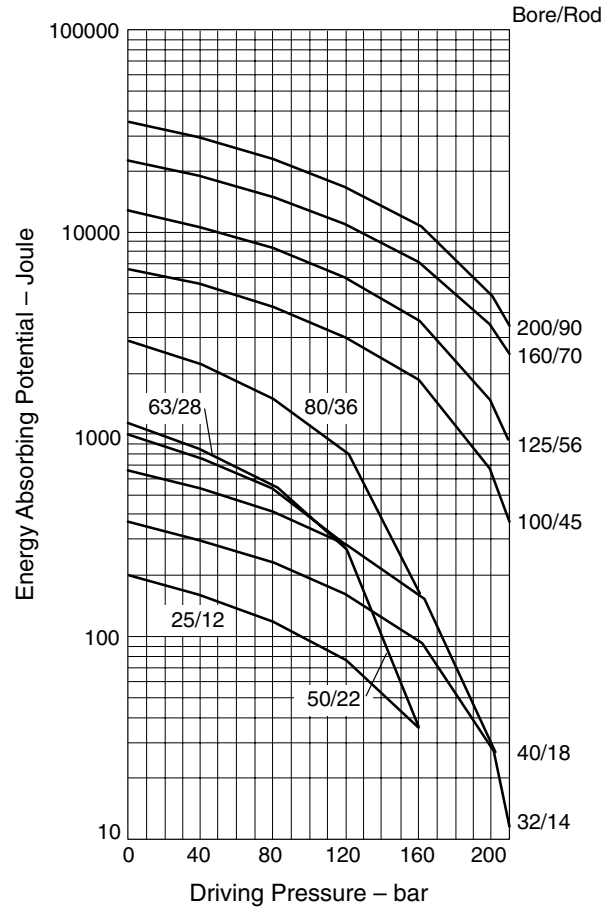

**TV Cap Cushion - Rod Retracting
Second Rod**

**TV Rod Cushion - Rod Extending
Second Rod**

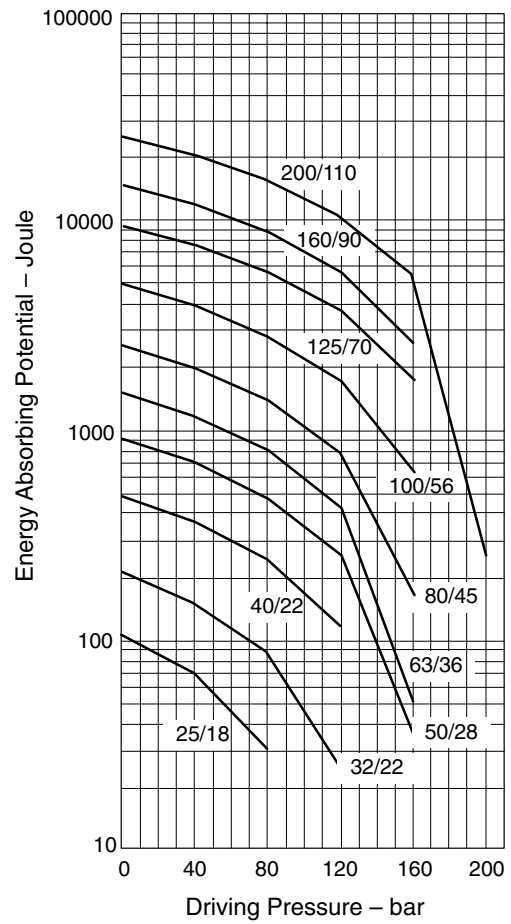
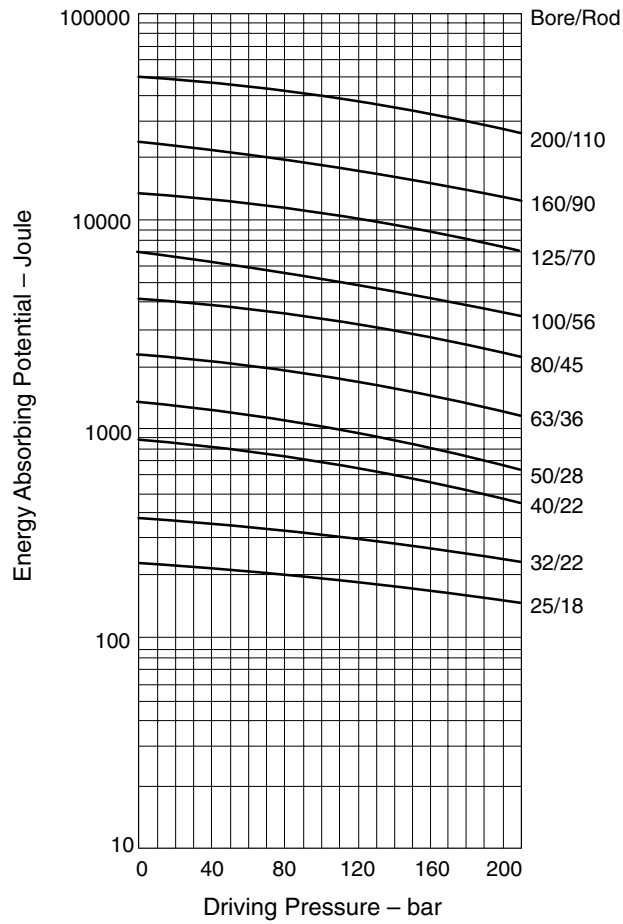

**TV Cap Cushion - Rod Retracting
Third Rod**

**TV Rod Cushion - Rod Extending
Third Rod**

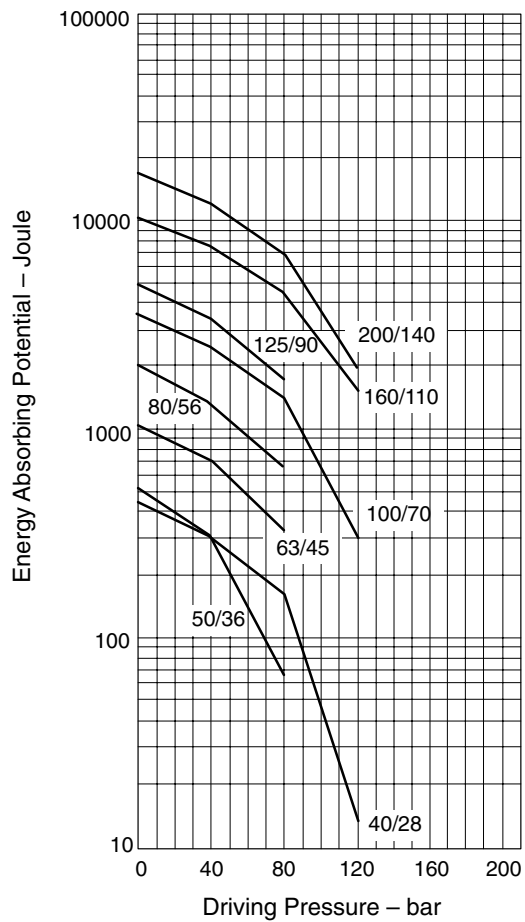
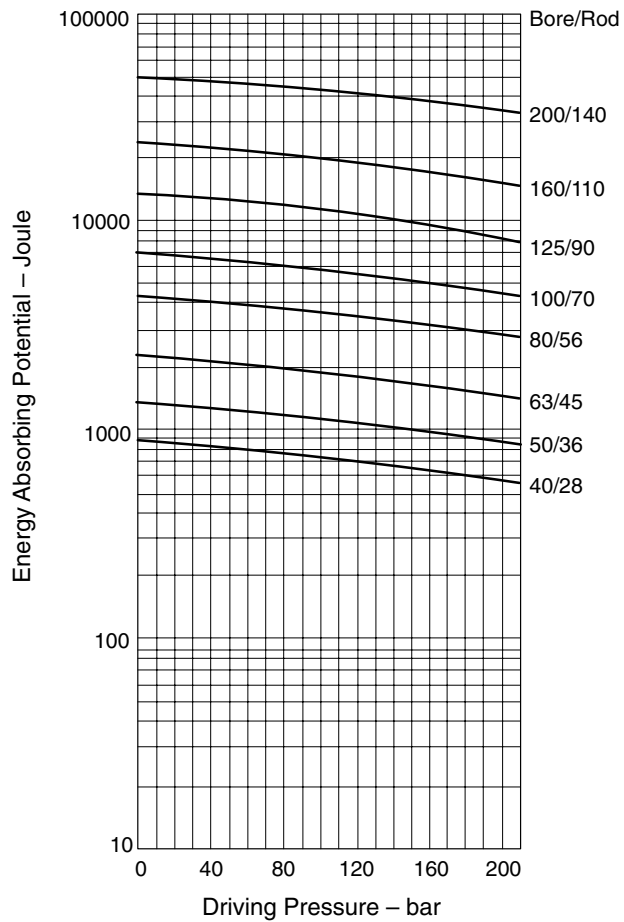

Weights

The following table lists approximate net weights of Series TV cylinders.

Weights shown are based on cylinders with standard rod diameter and single rod end. All weights are expressed in kilograms.

Double rod cylinder weight is equal to 1,15 times chart weight plus weight due to stroke.

Approximate Cylinder Weights

Bore ∅ (mm)	Rod ∅ (mm)	Zero Length Weight (kg)				Single Rod Weight per mm of Stroke (kg)	Double Rod Weight per mm of Stroke (kg)
		TV11 TV21 TV22	TV01 TV04 TV10 TV47	TV09 TV14 TV15	TV16 TV17 TV23		
25	12	1,2	1,2	1,7	1,2	0,004	0,005
32	14	1,6	1,6	2,2	1,6	0,006	0,007
40	18	3,5	3,7	4,9	3,6	0,009	0,011
50	22	5,3	5,5	7,3	5,5	0,013	0,016
63	28	7,4	7,8	10,4	7,7	0,019	0,024
80	36	14,2	14,9	19,9	14,7	0,031	0,039
100	45	19,2	20,2	26,9	20,0	0,046	0,058
125	56	37,6	39,5	47,4	39,1	0,074	0,093
160	70	61,6	64,7	77,6	64,0	0,113	0,143
200	90	113,0	118,6	142,4	117,5	0,158	0,208

Additional locations:

Vickers, Incorporated
7638 Pacific Avenue
White City, Oregon 97503-1091
U.S.A.
Phone: 503-826-2131
Fax: 503-826-3344

Vickers, Incorporated
Route 1, Box 17
250 Courtland Road
Decatur, Alabama 35603
U.S.A.
Phone: 205-353-2001
Fax: 205-351-9224



ATRiJOVA Company

Vickers, Incorporated
2425 W. Michigan Avenue
Jackson, Michigan 49202-3984
U.S.A.
Phone: 517-787-7220
Fax: 517-787-3450